

VarioString

MPPT solar charge controller

User manual

VarioString
VS - 120
48V-120A

VarioString
VS - 70
48V-70A



Accessories:

- | | |
|--------------------------------------|------------------|
| Remote control..... | RCC-02/03 |
| Temperature sensor..... | BTS-01 |
| External auxiliary relay module..... | ARM-02 |

Copyright © Studer Innotec SA



Studer Innotec SA
Rue des Casernes 57
1950 Sion – Switzerland
Tel: +41(0) 27 205 60 80
Fax: +41(0) 27 205 60 88

info@studer-innotec.com
www.studer-innotec.com

Contents

1	INTRODUCTION	5
2	GENERAL INFORMATION	5
2.1	About this user manual.....	5
2.2	Important safety instructions.....	6
2.3	Conventions.....	6
2.4	Quality and warranty	7
2.4.1	Exclusion of warranty.....	7
2.4.2	Exclusion of liability	7
2.5	Warnings and guidelines.....	8
3	MOUNTING AND INSTALLATION	8
3.1	Storage.....	8
3.2	Unpacking.....	8
3.3	Mounting place.....	9
3.4	Fixing/Dimensions	9
3.4.1	VarioString VS-120	9
3.4.2	VarioString VS-70	10
3.4.3	Assembling the cooling fan ECF-01	10
4	WIRING	11
4.1	Elements of the cable compartment	11
4.1.1	VarioString VS-70	12
4.1.2	VarioString VS-120	13
4.2	Connecting the battery	14
4.2.1	Precautions when using the batteries.....	14
4.2.2	Connecting the battery	15
4.2.3	Protection device of the battery	15
4.3	Photovoltaic generator (PV)	16
4.3.1	Dimensioning.....	16
4.3.2	Serial connection (chain or string) of PV modules	17
4.3.3	Parallel connection of PV module strings	18
4.3.4	Safe use of the photovoltaic modules	19
4.3.5	Protection devices.....	19
4.3.6	Cable cross-section and connection	19
4.3.7	Parallel connection of several VarioString.....	19
4.3.8	Extension of an existing installation.....	20
4.4	Earthing	20
4.4.1	Detecting an earthing fault.....	20
4.5	Lightning protection	21
4.6	Connecting the communication cables	21
5	POWER-UP OF THE EQUIPMENT	22
6	DISPLAY SYSTEM	23
6.1	The "SET" button (4)	23
6.2	"Night" standby indicator (1)	23
6.3	"Charge" cycle indicator (2)	23
6.4	"Error" indicator (3)	24
6.5	Charging current indicator (5)-(6)-(7)-(8)-(9)-(10).....	24
7	BATTERY CHARGING PROCESS	25
7.1	General points.....	25
7.2	Battery cycle	25
7.2.1	Bulk phase (1)	25
7.2.2	Absorption phase (2).....	25
7.2.3	Floating phase (4)	25
7.2.4	Equalization phase (3).....	25
7.2.5	Temperature compensation	26
7.3	Default battery charge cycle (original settings)	26
7.4	Recovery after deep discharge	26
8	REMOTE ENTRY (AVAILABLE AS FROM SOFTWARE VERSION 1.5.22)	27

9	CONFIGURING THE VARIOSTRING(S)	27
9.1	Configuring the equipment by means of the internal DIP switches	27
9.2	Displaying the equipment status using the remote control RCC-02/03.....	29
9.2.1	Displaying the status of a single unit system	29
9.2.2	Displaying the operating mode of the equipment (Info n° 15013,15014,15015)	31
9.2.3	Displaying security errors (Info n° 15049)	32
9.2.4	Displaying the values of a multi-unit system	32
9.2.5	Displaying messages and event history	32
9.3	Configuring the VarioString using the remote control RCC-02/03.....	33
9.3.1	The real time clock	33
9.4	Description of the VarioString parameters.....	33
9.4.1	Convention.....	33
9.4.2	Parameter access level	34
9.4.3	Organisation of the VarioString configuration menu	34
9.4.4	Basic settings {14000}.....	36
9.4.5	Battery management and cycle {14003}	36
9.4.6	System {14037}.....	40
9.4.7	Auxiliary contacts 1 {14070} and 2 {14122}	43
10	ACCESSORIES	46
10.1	Remote control and programming centre RCC-02/03.....	46
10.2	Temperature sensor BTS-01	47
10.2.1	Connecting the temperature sensor (BTS-01)	48
10.3	Auxiliary relay module ARM-02.....	48
10.4	Parallel connection cable	48
11	EQUIPMENTS COMPATIBLE WITH THE VARIOSTRING	48
11.1	Xtender inverter/chargers.....	49
11.2	Battery status processor BSP- 500/1200	49
11.3	Communication module Xcom-232i	49
11.4	Communication sets Xcom-LAN/-GSM	49
11.5	Communication module Xcom-SMS	49
11.6	Multi-protocol communication module Xcom-CAN.....	50
12	WIRING EXAMPLES	51
12.1	VarioString + RCC-02	51
12.2	Comments on the wiring examples 12.1	51
12.3	VarioString VS-70 + RCC-02.....	52
12.4	Comments on the wiring examples 11.3.....	52
13	MAINTENANCE OF THE INSTALLATION	53
14	PRODUCT RECYCLING	53
15	EU DECLARATION OF CONFORMITY	53
16	TROUBLE-SHOOTING	54
17	PARAMETER LIST	55
18	TECHNICAL DATA	59
18.1	General specifications	59
18.2	Input (PV generator)	59
18.3	Output (battery).....	59
18.4	Environment	60
18.5	Protection.....	60
18.6	Communication	60
18.7	Compliance.....	60
19	INDEX OF PARAMETERS	61

1 INTRODUCTION

Congratulations! You are about to install and use a device from the VarioString range. You have chosen high-tech equipment that will play a central role in the energy production of your solar electrical installation. The VarioString has been designed to work as a solar battery charger; its advanced and completely configurable functionalities will guarantee a perfect functioning of your energy system.

When the VarioString is connected to batteries and photovoltaic panels, it automatically recharges batteries in an optimum way with all the available solar power. The VarioString VS-120 can be connected to two strings of PV modules in different configurations (series, parallel, or independent). This configuration flexibility allows the user to optimise their installation. The accuracy of the Maximum Power Point Tracking (MPPT) algorithm, the high output and low internal consumption ensure an optimal valorisation of the energy produced by the PV modules.

The charge profile may be set freely according to the battery type or the operation mode. The charging voltage is corrected depending on the temperature thanks to the optional external sensor BTS-01.

The control, display and programming unit RCC-02/03 (optional) allows an optimal setup of the system and guarantees the user a permanent control over all important parameters for the installation with a clear display interface. Moreover, it allows recording the system data in order to analyse later its functioning (data logging).

The parallel operation of several chargers is possible and offers modularity and flexibility enabling an optimum dimensioning of your system according to your energy requirements.

The VarioString operates as an independent device but is also designed to be included into a Studer energy system together with the Xtender inverters/chargers, the BSP battery monitor, the control, display and programming unit RCC-02/03 and all Xcom communication modules. Working together, these different devices have a synchronised behaviour for a better management of the battery and of the solar resource.

Please read this manual carefully to ensure the perfect start up and operation of your system. It contains all necessary information regarding the operation of the VarioString charger. The installation of such a system requires special expertise and may only be carried out by qualified personnel familiar with the local standards in force.

2 GENERAL INFORMATION

2.1 ABOUT THIS USER MANUAL

This manual contains necessary information and procedures to install, configure, use and troubleshoot the VarioString solar charge controllers. It does not contain information about photovoltaic modules (PV) or batteries of various brands that can be connected. For this kind of information, please refer to the instructions of each specific manufacturer.

It covers the following models and accessories:

- MPPT solar charge controller: **VarioString VS-70, VarioString VS-120**
- Temperature sensor: **BTS-01**
- External auxiliary relay module: **ARM-02**

	<p>This manual is an integral part of the equipment and must be available for the operator and/or the installer at all times. Always keep it close to the installation.</p>
---	---





2.2 IMPORTANT SAFETY INSTRUCTIONS

This manual contains important safety instructions. Read carefully the safety and operation instructions before using the VarioString. Take into consideration all warnings mentioned both on the equipment and in this manual, strictly following all instructions regarding its operation and use.

This user manual is intended to serve as a guideline for the safe and efficient use of the VarioString. Anyone who installs or uses a VarioString can completely rely on this user manual and is bound to observe all the safety instructions and indications here in.

The installation and commissioning of the VarioString must be entrusted to qualified personnel. The installation and use must comply with the local safety instructions and standards in force in the country.

2.3 CONVENTIONS

	This symbol is used to indicate safety instructions which, if not followed, could result in serious personal injury or death to the operator or the user.
	This symbol is used to indicate a general danger for the user and/or a risk of material damage and/or the cancellation of the guarantee.
	This symbol is used to indicate a procedure or function that is important for a safe and correct use of the equipment. Failure to respect these instructions may lead to the cancellation of the guarantee or to a non-compliant installation.
	This symbol placed on the product indicates that its surfaces may reach temperatures higher than 60°C.
	This symbol placed on the product indicates that its use must follow the instructions in the user's manual.

In general, values important for the operation of the equipment (for example: battery voltage during absorption) are not mentioned and the parameter number is indicated in the following format: {xxxx}. The value of the parameter can be found in the table chap. 16.

In most cases, these values can be modified with the remote control RCC-02/03 (see chap. 10.1).

	The parameter table available at the end of this manual (chapter 16) must be kept updated in case the parameters are modified by the operator or the installer. If an authorised person modifies a parameter not included in the list (advanced parameters), the number of the modified parameter(s), the specifications of the parameter(s) and the new value set are to be indicated at the end of the table.
---	--

All values that are not followed by a parameter number may not be modified.

All digits and letters in brackets or in square brackets in the text of this manual refer to items represented in illustrations with a circle.

2.4 QUALITY AND WARRANTY

During production and assembly of the VarioString, each unit undergoes several checks and tests which strictly comply with established procedures. The manufacturing, assembling and testing of each VarioString are completely carried out in our factory in Sion (CH). The equipment warranty depends upon the strict application of the instructions in this manual.

The VarioString MPPT solar charge controller has a 5-year warranty (starting from the date of production against material and manufacturing faults). A defective product will either be repaired or replaced at the discretion of Studer Innotec.

2.4.1 Exclusion of warranty

No warranty claims will be accepted for damages resulting from handling, use or treatment that are not explicitly mentioned in this manual. In particular, damages arising from the following causes are excluded from the warranty:

- Voltage higher than 600V across PV terminals (independent or parallel configuration) or higher than 900V (series configuration).
- Accidental presence of liquids in the equipment or oxidation due to condensation.
- Damage resulting from falls, mechanical shocks or permanent or excessive vibrations.
- Modifications carried out without the explicit authorisation of Studer Innotec.
- Nuts or screws that have not been tightened sufficiently during the installation or maintenance.
- Damage due to atmospheric surge voltage (lightning).
- Damage due to inappropriate transportation or packaging.
- Disappearance of original identification marks.



Never take off or damage the rating plate showing the serial number. It enables to check and follow-up the data specific to each equipment and is vital for any warranty claim.

2.4.2 Exclusion of liability

The installation, commissioning, use, maintenance and servicing of the VarioString cannot be subject of monitoring by Studer Innotec. Therefore, we disclaim all responsibility and liability for damage, costs or losses resulting from an installation that does not comply with the instructions, a faulty operation or inadequate maintenance. The use of Studer Innotec equipment is in any case under the responsibility of the customer.

This equipment is neither designed nor guaranteed to supply installations used for vital medical care nor any other critical installation entailing potential risks of important damage to people or to the environment.

We assume no responsibility for the infringement of patent rights or other third parties rights resulting from the use of the MPPT solar charge controller VarioString.

Studer Innotec reserves the right to make any modifications to the product without prior notification.

Studer Innotec is not liable for incidental, direct or indirect damages of any kind, including any profit loss, revenue loss or damages caused to equipment or goods due to defective equipment.

2.5 WARNINGS AND GUIDELINES

The installation and commissioning of the VarioString must be entrusted to skilled and qualified personnel perfectly aware of the safety precautions and local rules in force. All elements connected to the VarioString must comply with the laws and regulations in force.

	<p>HIGH-VOLTAGE DC INSIDE THE CHARGE REGULATOR: DANGER OF DEATH</p> <p>When the VarioString is in operation it generates voltages that can be potentially lethal (up to 600V (VS-70) and 900V (VS-120)). Any work on or close to the installation must only be carried out by thoroughly trained and qualified personnel. Do not try to carry out ordinary maintenance on this product yourself.</p> <p>While working on the electrical installation, it is important to make sure that the source of DC voltage coming from the battery as well as the source of DC voltage coming from the photovoltaic generator, have been disconnected from the electrical installation.</p> <p>Even when the VarioString has been disconnected from the power sources, a potentially dangerous voltage may remain at the terminals. To eliminate this you have to wait for at least 5 minutes in order to allow the electronics to discharge. The task can then be carried out safely.</p>
---	--

No person is authorized to proceed with any change, modification or repair of the equipment without prior written authorisation from Studer Innotec. Only original parts should be used in authorised modifications or replacements.

Respect the maximum rated specifications of the equipment indicated on the type label.

	<p>The VarioString can be installed at altitudes up to 3000m. For installations at higher altitudes, please contact Studer Innotec SA.</p> <p>The VarioString is in overvoltage category II, in accordance with the norm IEC/EN 62109-1:2010 that considers all solar generators as being in overvoltage category II.</p>
---	---

3 MOUNTING AND INSTALLATION

	<p>The wiring and connection of the installation must be carried out only by perfectly qualified personnel. The installation material such as cables, connectors, distribution boxes, fuses, etc., must be appropriate and comply with the laws and regulations in force for the application in question.</p>
---	---

3.1 STORAGE

The equipment must be stored in a dry environment at an ambient temperature between -20°C and 60°C. Place the equipment at its mounting place at least 24 hours before commissioning in order to avoid thermal shocks and condensation problems.

3.2 UNPACKING

When unpacking, check that the VarioString has not been damaged during transportation and that all accessories listed below are present. Any fault must be immediately reported to the product distributor or the contact mentioned at the back of this manual.

Carefully check the packaging as well as the VarioString.

Contents in the VarioString box:

- VarioString
- Installation and operation manual
- Cable-glands for the battery cables
- Solar cable connectors, 1 pair (VS-70) and 2 pairs (VS-120)
- Communication cable

3.3 MOUNTING PLACE

The mounting place for the VarioString is particularly important and must fulfil the following criteria:

- Indoors
- Protected from water and dust in a location without condensation.
- Protected from any unauthorized person.
- In a place where the relative humidity does not exceed 95%
- In a place where the ambient temperature is between -20 and 55°C
- In mobile applications, it is important to select a mounting place that ensures no vibration.
- Protected from direct solar radiation or heat sources.
- It should not be mounted directly above the battery or in a cabinet with the battery
- The ventilation vents should be clear at all times and at least 20 cm from all obstacles that could alter the ventilation of the device.
- Given the norm IEC/EN 62109-1, the degree of pollution in the installation area should be at maximum PD2 for the VS-120 and PD3 for the VS-70.
- The support for the VarioString and the environment in which it is contained should not be flammable.

The presence of a heat source may significantly reduce its rated power. Similarly, insufficient ventilation may lead to the overheating of some internal components of the equipment. In this case, the device will automatically limit its power as long as this abnormal situation persists.

As far as possible, reduce exposure to sudden temperature variation: important heat variation may create undesired and harmful condensation inside the equipment.

3.4 FIXING/DIMENSIONS

	<p>The VarioString is a heavy equipment (5.5 kg (VS-70) and 7.5 kg (VS-120)) and must be mounted to a support (wall) designed to bear such a load. It is imperative to ensure a complete and safe fastening of the equipment. If simply hung, it may fall down and cause severe damages.</p>
---	--

The VarioString must be installed vertically. A distance of at least 5cm between the units and/or 20cm around the equipment is required to guarantee adequate ventilation.

If the VarioString is installed in a closed cabinet, it must have sufficient ventilation to guarantee that the ambient temperature is kept within the operating limits of the VarioString.

In motor vehicles, or when the support undergoes significant vibrations, the VarioString is to be mounted on anti-vibration elements.

3.4.1 VarioString VS-120

Upper support screw: screw into the wall a 6-8 mm diameter screw without washer until there is 1.6 mm between the head of the screw and the wall. Hang the device from the screw. If deemed

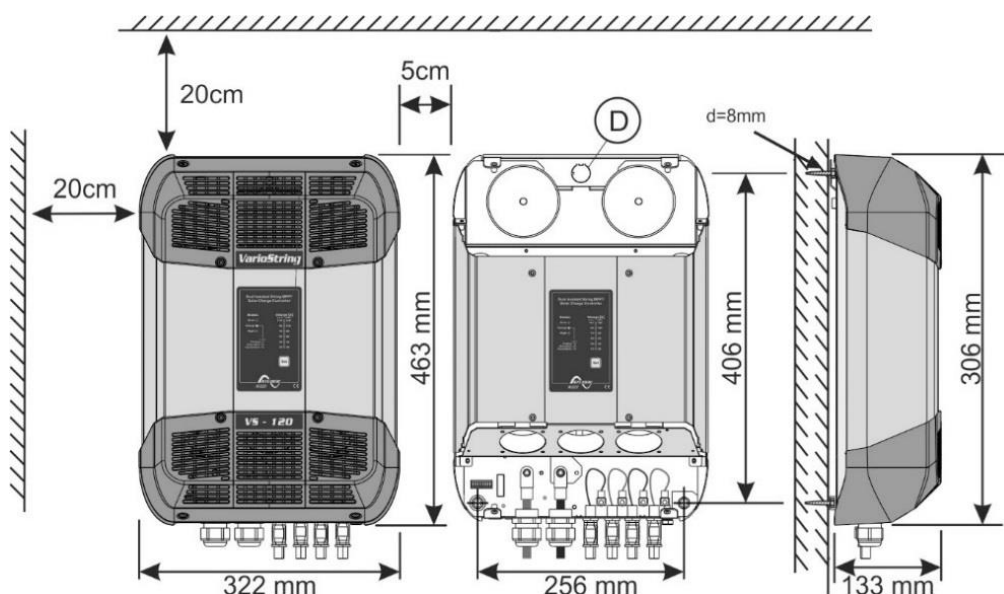

necessary, the upper support screw can be fully tightened after hanging the device. In theory this is only necessary in mobile applications. To access the upper support screw to fully tighten it, remove the upper plastic grate.

Lower support screws: remove the lower plastic grate which gives access to the cabling compartment. Carefully fix the device to the support with two screws (6-8 mm in diameter) using the two mounting holes located at the bottom left and right of the cabling compartment.

3.4.2 VarioString VS-70

The VS-70 enclosure is fitted with a support plate to be mounted on the back of the case using 4 screws M6, 8 mm long, and washers (see fig. hereafter), before wall mounting. Mount it vertically with the cable-glands downward.

The external cooling fan can be installed before or after the equipment has been mounted on the wall.

The 4 mounting screws of the enclosure must be completely tightened with a torque of (>3Nm - 10Nm<) in order to guarantee the IP 54 protection index. Any unused cable glands should be closed in a way that guarantees at least the same level of protection.

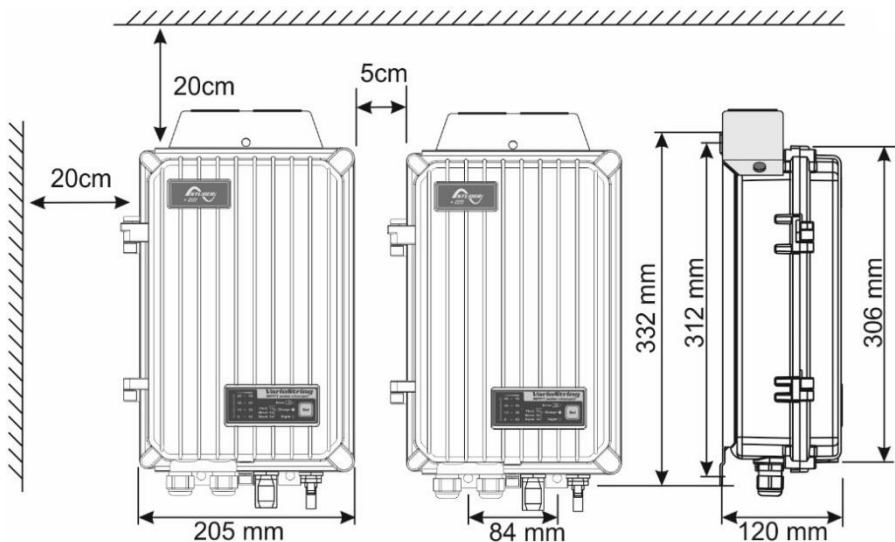
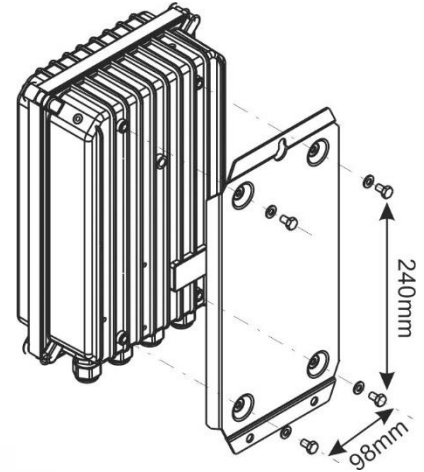

3.4.3 Assembling the cooling fan ECF-01

The VarioString VS-70 is supplied with an external cooling fan module (ECF-01). This module can be installed before or after mounting the VarioString VS-70, on the wall.



This fan has a degree of protection IP54 and can be exposed to water spray without damage. However, do not expose it to dirty water splashes in order to prevent mud or similar particles from blocking the mechanism.

Assembly instructions:

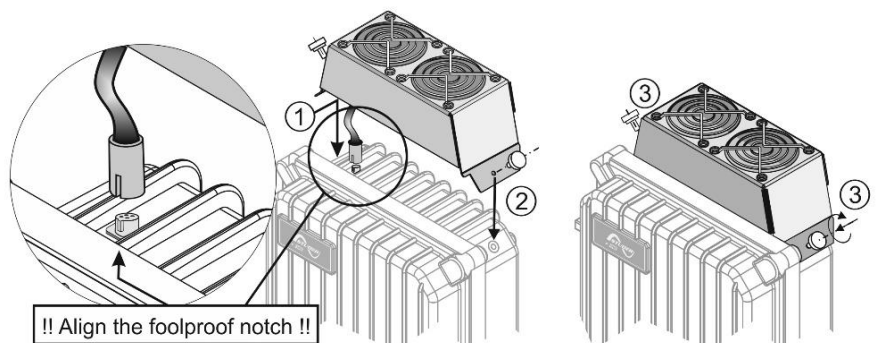
1. Remove the plastic cap and insert the connector until the click sound.
2. Position the cover by inserting the screws.
3. Fully tighten the two screws.



4 WIRING

	<p>The connection of the VarioString charger is an important step of the installation. It may only be carried out by qualified personnel, aware of the rules and regulations in force. The installation must always comply with these standards. The cross-sections of the cables connected to its terminals must comply with local regulations. All cables in use should be isolated with PVC, TFE, PTFE, FEP, neoprene or polyimide.</p> <p>Make sure that connections are completely tightened and that each wire is connected at the right place.</p>
	<p>The VarioString is intended to be connected exclusively to a source like a photovoltaic generator, excluding any other energy source.</p> <p>It is suitable for charging any type of lead-acid batteries. It is often possible to charge any other type of battery using proper settings and with the express approval of the battery supplier.</p>
	<p>The connection compartment of the VarioString must remain permanently closed while the apparatus is operating.</p> <p>Before opening, check that <u>all</u> voltage sources (battery and PV) have been disconnected or switched off and wait for at least 5 minutes before opening the equipment. It is imperative to close the protection cover on the connection terminals after each servicing.</p>

4.1 ELEMENTS OF THE CABLE COMPARTMENT

No.	Description	Comments
1	Terminal to connect the battery positive pole VS-70: M6, 5Nm torque, PG-16 (10-14mm) VS-120: M10, 8Nm torque, PG-21 (13-18mm)	This connection must be done using a protection and disconnection device if the pole has not been earthed. For mounting of the internal fuse, refer to sect. 4.2.2
2	Terminal to connect the battery negative pole VS-70: M6, 5Nm torque, PG-16 (10-14mm) VS-120: M8, 8Nm torque, PG-21 (13-18mm)	This connection must be done using a protection and disconnection device if the pole has not been earthed.
3	Connector (Sunclix) for negative pole of solar generator.	The solar generator wiring must be carried out in compliance with the voltage and current limits mentioned on the rating plate.
4	Connector (Sunclix) for positive pole of solar generator.	
5	Connector (Sunclix) for negative pole of solar generator. (VS-120 only)	
6	Connector (Sunclix) for positive pole of solar generator. (VS-120 only)	Only the mentioned original accessories can be connected to this connector.
7	Socket for connection of accessories BTS-01 or ARM-02 (battery temperature sensor and auxiliary relay module)	
8	Socket for communication cables and the remote control RCC-02/03.	RJ45 connector used for connecting equipment of the Xtender family. These connections must be carried out only with original Studer cables.
9	Termination switch	The switch must be placed in position O (towards (8)) when both connectors are used.
10	Configuration switches (DIP switch)	The various possible configurations are described in sect. 9.1
11	Real-time clock battery (type CR 2032)	The equipment is fitted with a battery lasting about 10 years.

No.	Description	Comments
12	Remote entry	Available as from software version 1.5.22. Allows the control of a function – to be defined by programming – by the closing of a dry contact or by the presence of a voltage across these terminals.
13	Jumper for programming of the remote entry	See sect. 8 – p. 27 in fig. 4.1.1 and 4.1.2. By default, they are positioned at A-1/2 and B-2/3.
14	Battery protection fuse	VS-70 : Fuse 100A/80V (sect. 4.2.2.2) VS-120 : Fuse CF8/150A/58V (sect. 4.2.2.1)

4.1.1 VarioString VS-70

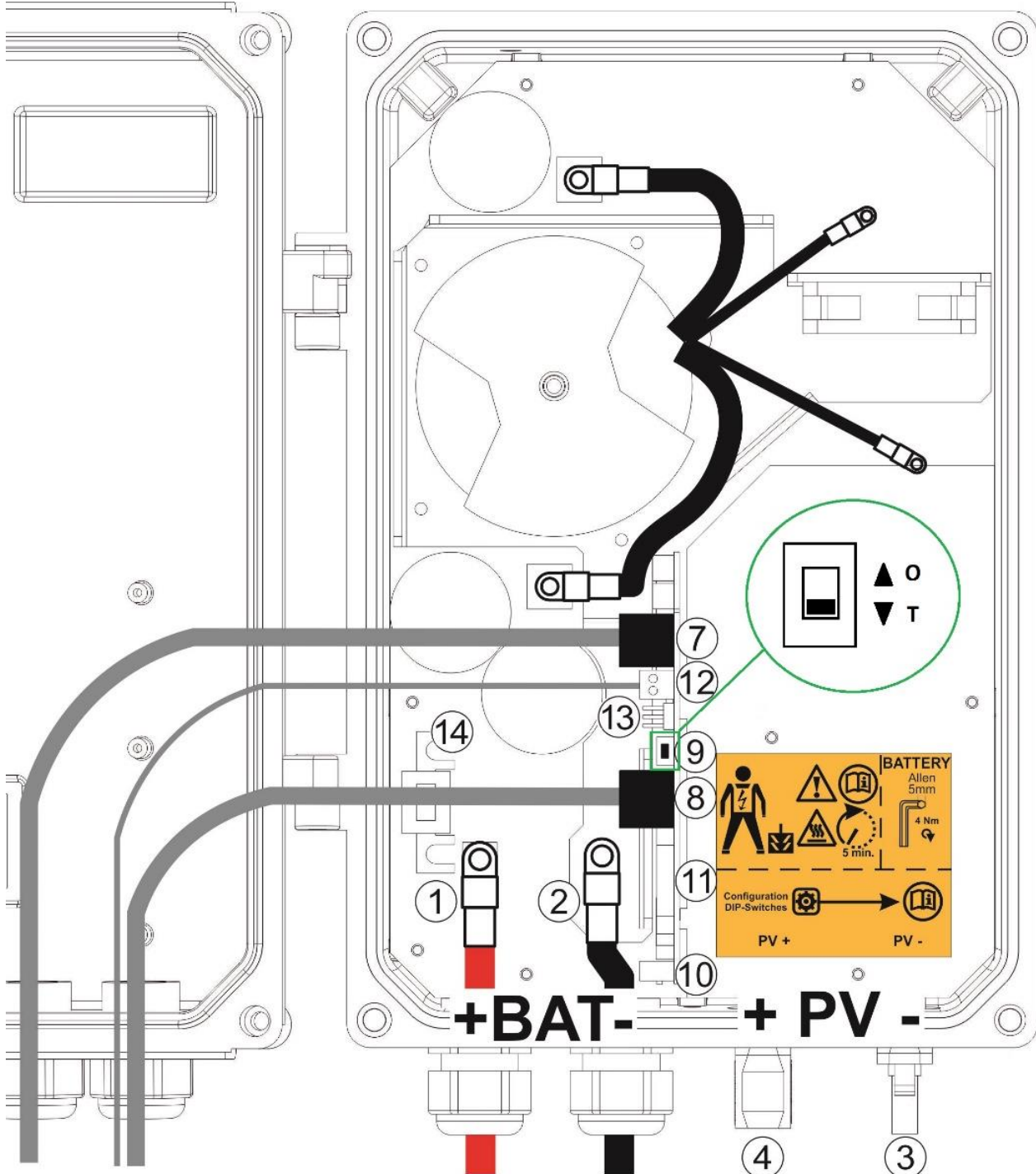

4.1.2 VarioString VS-120

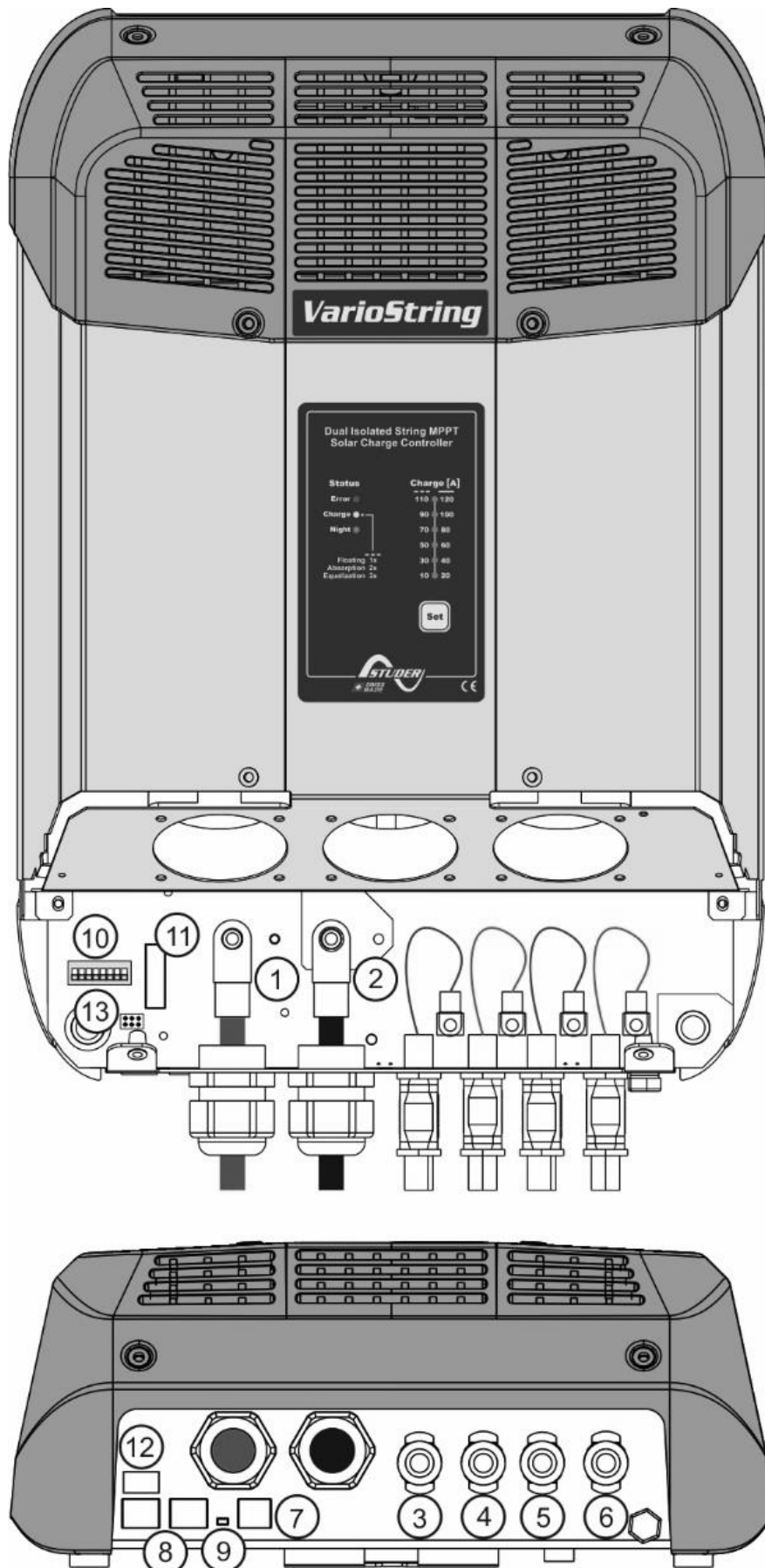

4.2 CONNECTING THE BATTERY

The VarioString is a device which DC (battery) connection is to be connected exclusively to a battery. Most of the time, lead-acid batteries with liquid (VLA, VRLA) or gelled (GEL) and AGM electrolyte may be used. It can be easily configured to create charge profiles that are compatible with these various types of lead-acid batteries.

In any case, the max charge current should be within the limit established by battery manufacturer. If necessary, the charge current can be limited with the aid of parameter {14001}.



Using the VarioString connected to any other type of DC source without battery is strictly forbidden and may cause significant damage to the equipment and / or to the source.



The use of other battery types like Ni-Cd, Li-ion or other is possible if the charge profile is properly programmed, in accordance with the specifications of the battery manufacturer, in agreement with the battery manufacturer and under the responsibility of the installer.

4.2.1 Precautions when using the batteries

The batteries should only be chosen, dimensioned and installed by qualified personnel, trained in this specific area. When working with batteries, a second person is required in order to give assistance in case of problems.

Lead-acid batteries with liquid or gelled electrolyte produce a highly explosive gas during normal use. Avoid any source of sparks or fire in the immediate vicinity of the batteries. The batteries must be kept in a well-ventilated place and installed so as to avoid accidental short-circuits when connecting.

Never try to charge frozen batteries.

It is advised to never work alone with batteries. The presence of a second person is necessary to provide assistance in the event of a problem.

Sufficient fresh water and soap must be kept close at hand to allow adequate and immediate washing of the skin or eyes affected by accidental contact with the battery acid.

In the event of accidental contact of the eyes with acid, they must be washed carefully with cold water for 15 minutes. Then immediately consult a doctor.

The battery acid can be neutralized with baking soda, among other things. A sufficient quantity of baking soda should be available for this purpose.

Particular care is required when working close to batteries with metal tools. Tools such as screwdrivers, open-ended spanners, etc., may cause short circuits. Sparks created by short-circuits may cause the battery to explode. Therefore these kinds of tools must always have isolated handles and never be placed on top of a battery.

When working with batteries, all metal jewellery such as rings, watches with a metal bracelet, earrings, etc., must be taken off. The current supplied by the batteries during a short circuit is sufficiently powerful to melt the metal and cause severe burns.

Batteries at the end of their life-cycle should be recycled in accordance with directives from the responsible local authorities or the battery supplier. The batteries should never be thrown into fire as they may explode. Under no circumstances should you try to take apart or dismount the battery, as they contain toxic and polluting materials.

For ungrounded battery systems, always check that they are not inadvertently grounded before starting working on the batteries.

Always follow carefully the instructions of the battery manufacturer.

If the battery voltage exceeds 68V, the charger turns off and starts again when the voltage is lower than 64V.

 A battery voltage higher than 75V can cause important damage or destroy the equipment. Such a voltage applied on equipment connected downstream like Xtender inverters/chargers or other, can cause important damage or destroy the equipment!

4.2.2 Connecting the battery

All connection cables as well as the battery cables must be mounted using cable restraints in order to avoid any pulling on the connection.

Battery cables must be as short as possible and the cross-section must comply with the regulations and standards in force. Tighten the clamps on the "Battery" inputs sufficiently.

 Each VarioString is connected directly to the battery using its own protective device. All other consumers or sources are connected directly to the battery through their own protective device.

Lead batteries are usually available in 2V, 6V or 12V blocks. In most cases, in order to get the correct operating voltage for the VarioString, several batteries must be connected in series. The capacity of the batteries can be increased using a parallel connection of several battery strings.

Some battery manufacturers limit the use or advice against parallel connection of battery strings. Strictly conform to the manufacturer's instructions of use.

 In multi-unit systems (connected to the same communication bus), all VarioStrings must be connected to the same battery bank.

4.2.2.1 VarioString VS-120

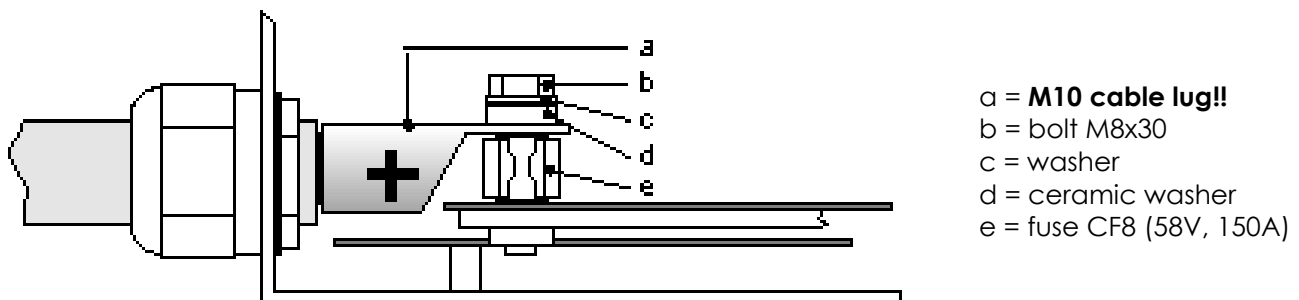

4.2.2.2 VarioString VS-70

See illustration on page 12, number (1) and (2). M6 cable lug.

4.2.3 Protection device of the battery

The battery cables must be as short as possible. The recommended cable cross-section is 25mm² for VS-70 and 50mm² for VS-120. The protection devices (battery side) must be 80A for VS-70 and 125A for VS-120. The protection device must be installed as close as possible to the battery. The recommended cross-section of battery cable is valid for lengths up to 3m. Beyond this length, it is recommended to oversize the section of the battery cables.

Any other sources or loads existing on the battery must be connected using their own protection devices. Never connect them to the protection device(s) of the VarioString.

 An annual check of all the connection tightness is recommended. In mobile installations, the connection tightness should be checked more often.

 Battery cables must always be protected by a protection and disconnection device (fuse, circuit breaker) on the pole not connected to earth. The protection device must be rated according to the cable cross-section but must not exceed 1.25 x VarioString maximum current. It will be mounted as close as possible to the battery.

4.3 PHOTOVOLTAIC GENERATOR (PV)

The VarioString may accept the following maximum input voltages:

VS-120	<ul style="list-style-type: none"> • 600 V max for independent and parallel cabling • 900 V max for series cabling
VS-70	<ul style="list-style-type: none"> • 600V

	The whole solar system must be installed according to protection class II.
---	--

	The capacitor banks inside the VS-120 hold a DC voltage for several minutes after the PV input is disconnected. It is necessary to wait 10 minutes before reconnecting the PV input cables after making any changes to the PV array or its wiring.
---	--

	When connecting the PV inputs in parallel, it is necessary to first connect the VarioString MPPT channel inputs in parallel, and then connect the PV array positive and negative cables to the paralleled VarioString positive and negative inputs.
---	---

4.3.1 Dimensioning

The solar generator is dimensioned to cover an important part or the entire power requirement of the system. Once the power has been decided upon, it will be distributed among one or more solar charge regulators, wisely combining the modules among them. These combinations in series and in parallel must be carried out according to the voltage and current limits of the VarioString solar charge controller.

The possible operating range of the VS-70 and the VS-120 within different configurations are indicated in the following graph (blue (A): one independent input, VS-70, red (B): two inputs in parallel, green (C): two inputs in series).

	The VS is on night mode when there is not enough voltage in the PV input. The VS leaves the night mode and starts charging when the PV voltage remains above 110V for 3 seconds. The starting voltage has a 10V operational hysteresis to leave the night mode. Once the VS starts charging, it works within the MPP tracking range from 100 to 600V. The starting voltage value is 220 when the VS-120 is wired in series (MPP tracking range from 200 to 900V).
---	---

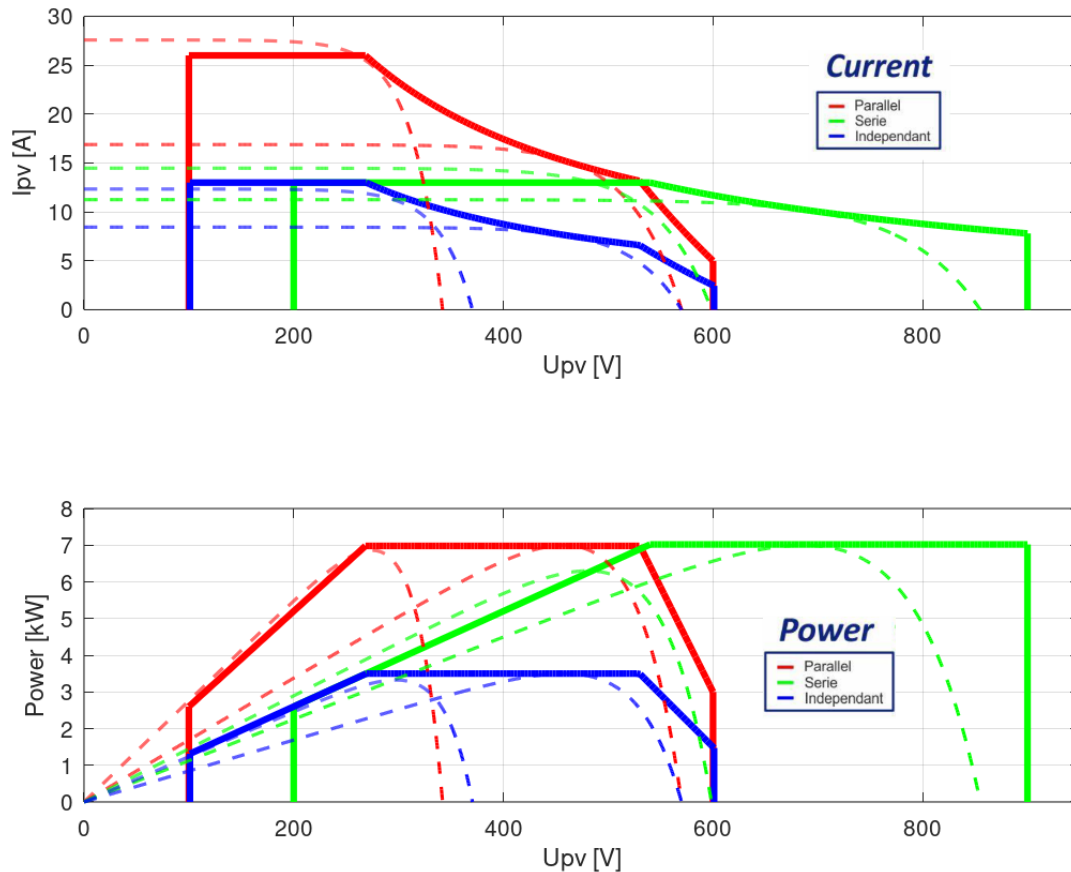

The graph below shows the battery current (I_{BAT}) and PV current (I_{PV}) profiles for different temperatures according to the operating voltage.

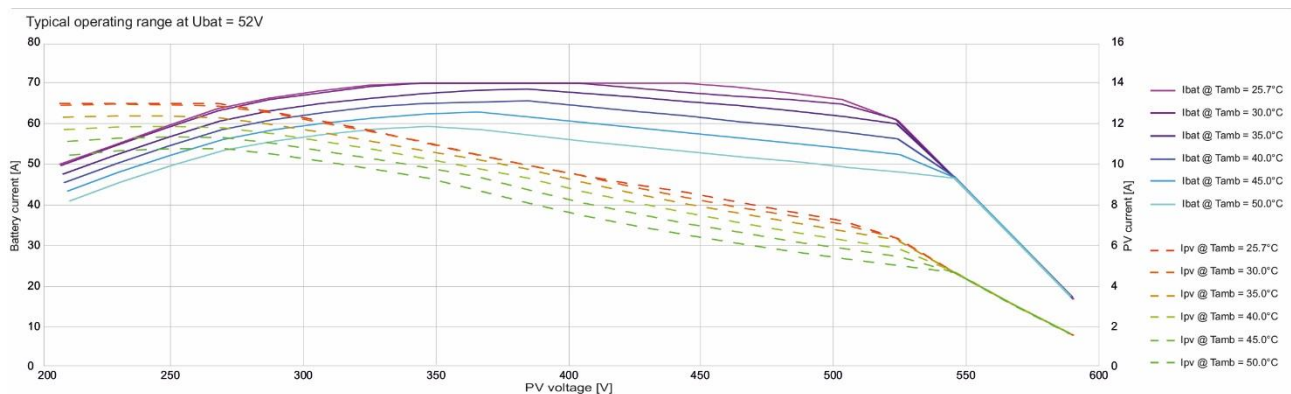

4.3.2 Serial connection (chain or string) of PV modules

To get the optimum voltage, connect the PV modules in series to form a string with the desired voltage.

When using the two entries of the VarioString VS-120 in series, the + terminal of the PV1 entry (6) should be connected to the + pole of the PV generator. The - terminal of the PV2 entry (3) should be connected to the - pole of the PV generator and a bridge should be made between the entries (4) and (5).

The open-circuit voltage of the string must be lower than 600V under any **temperature** and irradiation conditions. A 10 to 20% margin is recommended in order to cover these unknowns. When the two inputs are used in series on the VarioString VS-120, the **maximum open-circuit voltage** should not surpass 900V.

To establish the maximum numbers of the PV modules connected in series in the same string, use the following formula: $600V / (U_{oc} * 1.1)$. (Example: $600 / (22 * 1.1) = 24.79$). The result must be **rounded down** (i.e. 24 modules - of 22 Voc - in series for the above example).

The table below gives an idea of the possible arrangements for common PV modules according to the number of cells or their type:

36 cell module Voc < 25V	60 cell module Voc < 42V	72 cell module Voc < 50V	Thin film module Voc < 110V	
max.	max.	max.	--	
21	12	10	4	For VS-70 or VS-120 with independent or parallel inputs
32	19	16	7	For VS-120 with two inputs in series

Beware of the PV module temperature! The above values are for modules under standard test condition (STC).

4.3.3 Parallel connection of PV module strings

To get the required charging power, 2 or more strings can be connected in parallel. Each string connected in parallel shall be composed of the same number of modules of the same type.

When using the two entries on the VarioString VS-120 in parallel (up to 26A) it is necessary to physically connect the two negative terminals (3) and (5) as well as the two positive terminals (4) and (6).



The two inputs can only be put in parallel when there is no voltage present. The four inputs (3), (4), (5) and (6) should be disconnected at least 10 minutes before connecting the "Y" cable in parallel.

1. Disconnect all PV sources and wait 10 minutes.
2. First connect the inputs (3) and (5), and (4) and (6) with the "Y" parallel cable.
3. Only at this point, the PV generators may be connected to the "Y" cables.

The number of strings connected in parallel depends on the power of each module. The sum of the power of all the panels connected to a VarioString should not exceed the power that the VarioString can charge.

The recommended number of strings to be connected in parallel is equal to 3500W divided by the power of a string and rounded down to the nearest whole number. (see table below)

For example, with 12 modules of 110W in series: $3500 / 1320 = 2.65 \Rightarrow 2$ strings (2640W) can be connected in parallel.

If both VarioString inputs are connected in parallel, for the strings of 12 modules in series mentioned above, 5 strings could be connected in parallel ($7000 / 1320 = 5.3 \Rightarrow 5$).

Maximum recommended power for the solar generator		
	VS-120	Battery
MPPT input 1	3500W	48V
MPPT input 2	3500W	48V
Total	7000W	48V

The PV generator can be over-dimensioned in order to get the required charging power even when solar irradiation is lower. In this case, a part of the solar energy will be lost when the solar irradiation is higher because the VarioString will reach its current limit and curtail power output. By looking at the example above, 3 strings could be used however the maximum power of 3960W will not be reached as the VarioString will limit the power to a maximum value of 3500W.



The VarioString has a current limit. At any given time, the maximum power of the VarioString depends on the charging phase voltage of the battery. For example, if the charging phase is Bulk, and the battery voltage is 50V, the maximum power output for the VS-120 is $120A * 50V = 6000W$ and for the VS-70 $70A * 50V = 3500W$. Even if more solar energy is available, the battery charge current will not exceed 120A (VS-120) and 70A (VS-70).

4.3.3.1 Maximum current of the solar generator

The maximum current of the solar generator is limited to 13 A for the VS-70 and the VS-120 when connected in series or independently (13A per input) or to 26A for the VS-120 when connected in parallel.

In any case, the VarioString will limit the charging current (battery) to its rated current of 120A for the VS-120 or 70A for the VS-70.

4.3.4 Safe use of the photovoltaic modules

	<p>The VarioString is meant for PV generators supplying up to 600V (900V in series). This voltage is dangerous for human beings.</p> <p>During the installation or the maintenance of the system, it is imperative to make sure that no dangerous voltage may surge in the system. The disconnection device must be open and secured against any accidental reclosing.</p>
---	--

4.3.5 Protection devices

Wiring protection devices (fuses, circuit breakers) connecting the PV generator to the VarioString must be installed in accordance with local standards and regulations in force.

The DIN VDE 0100-712 standard prescribes a switching device on all poles between the PV generator and the charge regulator. This device must be supplied by the installer.

PV modules are often exposed to stormy weather. It is highly recommended to install lightning protection (see chap. 4.5).

4.3.6 Cable cross-section and connection

The connection cable cross-section must be chosen according to the short-circuit current of the PV generator and the local installation rules. PV connectors of Sunclix type do not need any special tools for mounting. They accept cables between 2.5 and 6mm² (exterior of 5 to 8mm²). Strip the cable 15mm to attach the Sunclix connector.

4.3.7 Parallel connection of several VarioString

As many VarioStrings as necessary can be connected in parallel on the same battery bank according to the battery capacity. Each will have its own independent solar generator (connected in independent, parallel or series configuration) and include its own disconnection and protection device to the battery.

	<p>Under no circumstances should PV module inputs of several VarioString be put in parallel.</p>
---	--

Up to 15 VarioStrings can be synchronized and interconnected to the same communication bus (see chap. 4.6) on a single system. Beyond these 15 units, any additional unit will not be interconnected and thus their battery cycles will work independently.

Solar generators may be of various types and be orientated differently. Each VarioString will adjust the optimum point of the PV generator independently of the other units connected to the same battery.



	<p>In multi-unit systems (connected to the same communication bus), all VarioStrings must be connected to the same battery bank.</p>
---	--

	<p>When the VarioString units are not synchronized, they must be programmed in the same way and it is recommended to not activate the periodical equalization function. The equalization can be started manually or will be done by the synchronized units.</p>
---	---

For multi-unit systems, the devices are connected to each other by a communication bus (see chap. 4.6) via the connectors (8) and a cable (ref. CAB-RJ45-8-2) with a maximum length of 5 meters.

As long as they are correctly connected together by the communication cable, the VarioString

automatically synchronize the battery charge cycle.

	When the devices are in the voltage regulation phase, their respective currents may considerably differ. These differences have no effect at all on the charge quality.
	If a VarioString is connected to another compatible device (Xtender, VarioTrack, VarioString, BSP, RCC, Xcom) with the same communication bus, it is highly recommended to make a software update of all components in the system in order to guarantee all functionalities.
	During the commissioning of the equipment in a multi-unit configuration, the system checks automatically the compatibility of the software versions and may prevent the operation in case of incompatibility. An upgrade of the installation must then be carried out by means of the RCC-02/03 remote control using the latest manufacturer's software version (read the user manual for the control and monitoring unit RCC-02/03 to carry out this operation).

4.3.8 Extension of an existing installation

In interconnected installations, if the software is compatible, it is possible to extend an existing installation by adding one or several (up to 15) VarioString units in parallel.

4.4 EARTHING

The VarioString is a Class I protection equipment, its metal case must be earthed by means of the grounding screw, included for that purpose.

 = protective earth (connected to the enclosure of the equipment).

The solar generator (as well as its wiring) must be Class II isolated.

The cross-section of the earthed cable must not be less than 16mm².

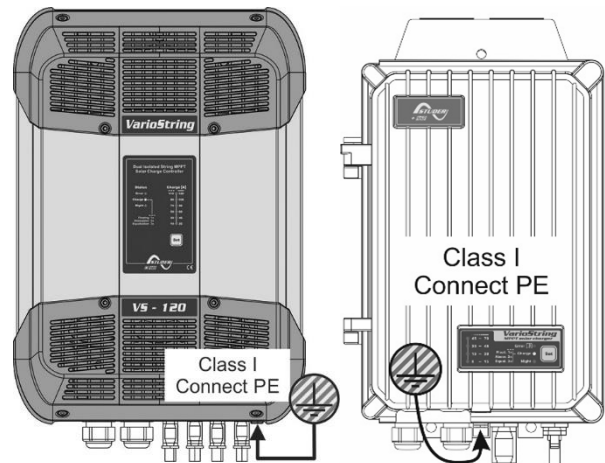

	The whole solar system must be installed according to protection class II.
---	--

In any case, the protective earth must be connected in accordance with local standards and regulations in force. The protective earth of the equipment must at least be connected to the earthed ground of all the Class I equipment after and before the VarioString (equipotential connection). The information, notes, recommendations and diagrams reported in this manual are subject to local installation rules. The installer is responsible for the conformity of the installation with the local standards in force.

4.4.1 Detecting an earthing fault

The choice of earthing system for the DC circuit is an important factor for the individuals' safety. Once the decision is made the VarioString can check the continuity of the earth connection.

In case of failure of this connection, the LED (3) (see sect. 6) lights up indicating the fault. A permanent message (requiring a validation) is displayed on the RCC if present.

The parameters {14040}, {14041} and {14042} allow establishing the type of control to be carried out or the absence of control as set by default.

4.5 LIGHTNING PROTECTION

The VarioString has internal protections against lightning by means of surge protection devices. These devices have an energy dissipation capacity limited to 3,5kA (8x20 μ s) which guarantees a certain protection level but are not a total protection against lightning. According to the installation site, it is highly recommended to develop a protection strategy specific to your installation. The strategies depend on various factors specific to each site; therefore, we recommend a professional approach to this issue.

	Damages due to lightning often generate significant costs (replacement of all electronics) which are not covered by the manufacturer's warranty.
---	--

4.6 CONNECTING THE COMMUNICATION CABLES

The VarioString is fitted with 2 connectors RJ45/8 (8) (see chap. 4.1) that enable to transfer information via a communication bus to other VarioStrings or to other equipment such as the RCC, the BSP or the Xcom having the proprietary protocol of Studer Innotec. In this case, the installation should be stopped and de-energized (the protection devices of power sources and loads should be open) to complete the cable connection and **positioning of the termination switches** of all the devices connected to the communication bus.

	The termination switch of the communication bus "Com. Bus" (9) remains in position T (terminated) except when both connectors are used. In this case and only in this case, the switch must be placed in the O (open) position. If one of the two connectors is not used, the termination switch (9) will be in position T.
---	---

The maximum total length of the communication bus is 300m. Due to a line voltage drop, it is recommended to install only one RCC module at the end of a 300m line or a max of 2 modules at the end of a 150m line. All the other modules of the system must be placed within the same radius of a few meters (technical room).

	A maximum of 3 RCC-02/03 or Xcom-232i may be connected to the same communication line with a VarioString.
---	---

	If a VarioString is connected to another compatible device (Xtender, VarioTrack, BSP, RCC, Xcom) with the same communication bus, it is highly recommended to make a software update of all components in the system in order to guarantee all functionalities.
---	---

	The RCC-02/03 or Xcom-232i should not be placed between two devices connected to the battery (Xtender, VarioTrack, or VarioString).
---	---

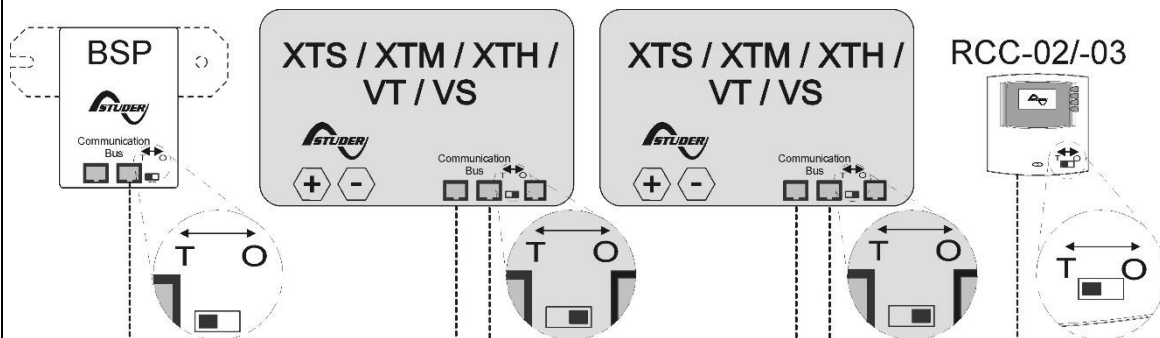

5 POWER-UP OF THE EQUIPMENT



It is imperative that the closing cover for the connection compartment is installed and screwed tight before energizing the installation. There are dangerous voltages inside the cable compartment.

If special configurations or settings are required for the system and they are set via internal buttons or switches (DIP switch, see chap. 9.1), they should be set before connecting the PV modules.

The connection of the VarioString must be carried out in the following order. Any disassembly shall be carried out in the reverse order. Before closing the protections and energizing the equipment, check the polarity.

- A. Connecting the battery: on the BAT+ and BAT- terminals
 - Check that the VarioString switches on (green LED "NIGHT" lights up on the control panel)



When connecting the cable to the second battery pole there will be a spark. This is normal.

- B. Connecting the photovoltaic panels: on the PV+ and PV- terminals
 - Check the PV voltage seen on the RCC. (if present)
 - Check the operation of the charger and the effective charging of the batteries when it is sunny.

Your installation is now in operation. If the system requires specific configurations or settings, carry them out immediately. Settings must be programmed by means of the remote control RCC-02/03 as per chap. 9.2 or by means of the internal DIP switches as per chap. 9.1.

Saving of data in the datalog is activated only after the VarioString has completed the automatic detection of the cabling type of the PV generators. In the case that the cabling configuration is entered manually, the datalog is activated immediately.



If the VarioString has been accidentally connected in reverse (battery reverse polarity on the panel input), it is likely that the protection device on the battery cables is open. In that case, carefully check the battery polarity, the wiring and the VarioString's internal fuse (VS-70 : 80V, 100A) (VS-120 : CF8, 58V, 150A) that protects against this situation. If the VarioString still does not work, after having closed or replaced the protection device (f) (chap. 12.1), despite having a correct polarity and voltage of the battery, it must be brought back to your reseller for repair.

6 DISPLAY SYSTEM

The VarioString is fitted with a “Set” button and light indicators on the front of the equipment allowing a clear identification of the operating mode.

6.1 THE “SET” BUTTON (4)

The “Set” button can be used to start an equalization cycle manually if this phase is authorized by the initial settings of the equipment. The equalization phase will be authorized as from the beep after having pressed the “Set” button (4) for 2 seconds. The “Charge” light indicator flashes 3x as long as the equalization phase is not completed. The equalization can be interrupted by pressing a second time for 2 seconds: a double beep indicates that the function has been cancelled. The indicator (2) stops flashing 3x confirming the cancellation.

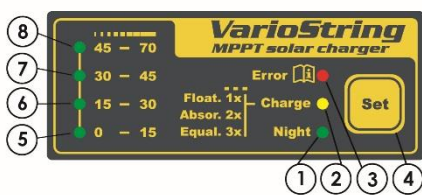

Pressing the “Set” button (4) for 5 seconds until the second beep turns off the VarioString. It starts again by pressing the “Set” button for 5 seconds.

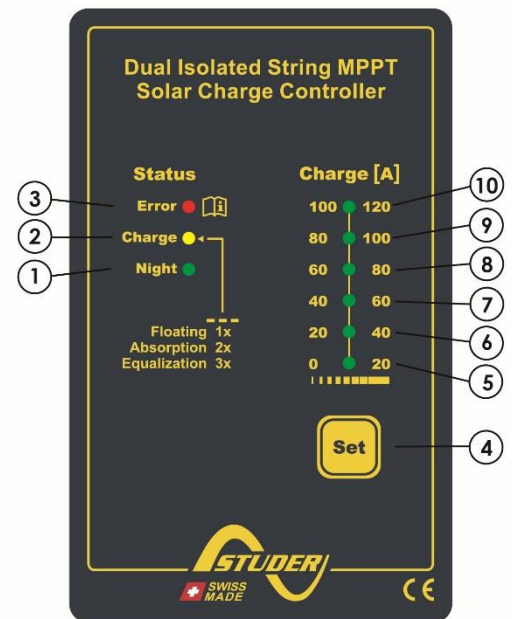



When the VarioStrings(s) are connected to an Xtender system and the synchronization {14036} is activated, the manual equalization can be started only during the battery cycle of the Xtender which will then pilot the VarioString to carry out an equalization phase. In “synchronized” mode, the cycle state - floating, absorption, equalization - are indicated. The “charge” LED (2) and the indicator for the amount of charge are used when the equipment is operating.

6.2 “NIGHT” STANDBY INDICATOR (1)

This green indicator lights up when the VarioString is connected to a battery and ready to operate but there is no PV voltage (at night or when no PV module is connected) or it is too low. This indicator flashes when there is a PV voltage but it is insufficient to charge the batteries (at the beginning or at the end of the day). In order to save the battery power, the VarioString charger turns off and goes in standby mode when this indicator lights up or flashes. It will then consume less than 1W. The charger automatically switches on again when the sun starts shining and PV voltage goes back above the battery voltage.

6.3 “CHARGE” CYCLE INDICATOR (2)

This yellow indicator lights up when the sun is shining and the photovoltaic generator produces enough voltage for charging the batteries. Various flashing modes enable to distinguish in what phase the regulator is. This indicator lights up continuously during the bulk phase. It flashes 1x during the floating phase, 2x during the absorption phase and 3x during the equalization phase.

In “synchronized” mode, the cycle state – bulk, floating, absorption, equalization - are indicated.

6.4 “ERROR” INDICATOR (3)

The table below describes the type of error according to the number of times this indicator blinks red.

Indic.	Indicated error	Comment
Off	No problem	If no indicator lights up, the equipment is de-energized.
On	The equipment is OFF	The equipment is energized but it does not operate because of a user command (the “Set” button has been pressed for 5s).
Blinks 1x	Battery low voltage warning	The equipment is still operating but shows that the battery is lower than 40V.
Blinks 2x	Earth fault	The VarioString detects an abnormal situation which does not correspond to the programmed value of the parameter {14040}, {14041} and {14042} checking the state of the earth connection.
Blinks 3x	Power reduction or stop due to an excessive temperature in the equipment.	This may be due to an excessive ambient temperature, exposure of the equipment to a heat source (sun) or to deficient or impeded ventilation.
Blinks 4x	Battery voltage higher than 68V	Check the cause of this excessive voltage. The equipment automatically starts again when voltage returns to a value lower than 64V.
Blinks 5x	The PV voltage is higher than the set value of the max operating limit.	The PV voltage exceeds the max limit (600V in parallel or independent, 900V in series). The equipment will stop or won't start. See also chap. 4.3.2.
Blinks 6x	Software incompatibility in a system	The different parts of the system's equipment must have the same software version to function properly. Proceed with the update following the procedure in the RCC-02/03 manual.
Blinks 7x	Not used	
Blinks 8x	The PV current is higher than the set value of the max operating limit.	The PV current exceeds the max limit (13A in independent or in series, 26A in parallel). The equipment will stop or won't start. See also chap. 4.3.3.1
Blinks 9x	Error in cabling of PV modules	The cabling specified by the parameter {14002} does not correspond to the cabling detected by the device. Only VS-120.
Blinks 10x	Other errors	Internal error in system

6.5 CHARGING CURRENT INDICATOR (5)-(6)-(7)-(8)-(9)-(10)

These indicators work as a type of histogram. They blink or are lit up continually to indicate the range of charge current from the VarioString given in the table to the right.

Example with the VS-120:

For a charge current of 65 A, the LEDs (5, 6, and 7) are lit up continuously while the LED (8) is blinking.

The RCC-02/03 remote control allows a complete and detailed display of the VarioString's behaviour (see chap. 10.1).

Indicator nr	State	Signification	
		VS-70	VS-120
LED (10)	Lit	-	120A
	Blinking	-	100-120A
LED (9)	Lit	-	>100A
	Blinking	-	80-100A
LED (8)	Lit	>70A	>80A
	Blinking	45-70A	60-80A
LED (7)	Lit	>45A	>60A
	Blinking	30-45A	40-60A
LED (6)	Lit	>30A	>40A
	Blinking	15-30A	20-40A
LED (5)	Lit	>15A	>20A
	Blinking	0-15A	0-20A

7 BATTERY CHARGING PROCESS

7.1 GENERAL POINTS

The VarioString has many parameters that can be modified by the user or the installer in order to adapt the equipment to the energy system the best possible way. The factory values of these parameters are reported in the table at the end of this manual (see chap.16).

These parameters can be modified by means of the remote control RCC-02/03 (optional) (see chap. 10.1) and for some of them, a basic configuration can be done using the DIP switches (10) inside the equipment (see chap. 9.1).

7.2 BATTERY CYCLE

The VarioString is a fully automatic solar charge regulator designed to guarantee an optimum charge for most lead/liquid acid, lead/gel or AGM batteries. The battery charger enters automatically into operation as soon as the irradiation is sufficient and the photovoltaic panel voltage is higher than 200V. The "Charge" indicator (2) lights up or flashes depending on the on-going charging phase.

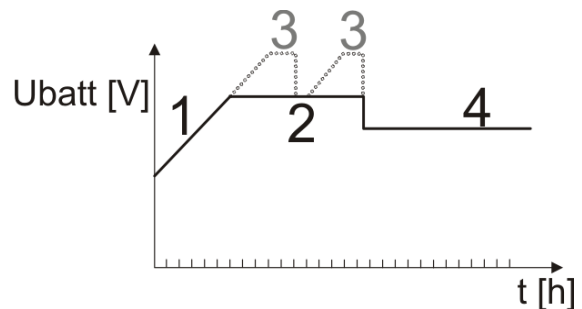

The batteries can be fully charged by the successive phases 1 to 4 described hereunder.

7.2.1 Bulk phase (1)

The bulk phase is the stage when the voltage of the battery rises thanks to the maximum available current (VS-70: 70A / VS-120: 120A) produced by the photovoltaic generator depending on the irradiation at the time. It is important that the max battery charge current be set according to the battery specifications to prevent damaging them. This current can be limited with parameter {14001} "maximum output current". It is possible that these currents are not reached if the generator power is not sufficient because of its dimensioning, solar power, silicon temperature (crystalline cell), or because the ambient temperature is excessive (or the ventilation is insufficient).

7.2.2 Absorption phase (2)

The absorption phase can be disabled by parameter {14008}. The maximum voltage that can be reached will be the floating voltage {14005}. It is the case when charging a Li-Ion battery.

This charging phase, of a limited duration {14011}, allows the battery to absorb a maximum of power while limiting its voltage {14009}. As soon as this absorption voltage is reached, the duration of the phase is counted down as long as the voltage remains higher than the floating phase {14005}. The end of the absorption triggered by the current {14012} can be enabled if necessary. If the charging current is lower than the end of absorption current {14013} whereas the voltage limit is reached, the absorption phase is considered finished.

7.2.3 Floating phase (4)

When the battery is completely charged, a constant reduced voltage {14005} is applied on the battery. This voltage prevents self-discharge and keeps the battery at its maximum charge level and reduces to the minimum the water evaporation that would occur at a higher voltage.

7.2.4 Equalization phase (3)

i The default battery cycle is suitable for a large number of batteries, whether gel or not, because the equalization phase is not activated.

This phase is allowed {14017} only for open batteries with liquid electrolyte. During this phase, the set voltage limit for the battery {14021} is temporarily {14022} higher. It allows on one hand to equalize the electrolyte density through mixing (corrosion control) and on the other hand to equalize the charge among the cells of the battery.

When this phase is authorized, it can be started manually by pressing for 2 seconds the "SET" button on the front of the VarioString. The countdown for the equalization time starts as soon as the equalization voltage {14021} is reached and lasts as long as the battery voltage is higher than the absorption voltage {14009}.

When authorized, the equalization phase is carried out at fixed intervals {14023} before the absorption phase. The equalization phase may be applied after the absorption phase by modifying parameter {14019}. During this phase, the charge current value can be limited by the parameter {14020}.

By default, equalization is forbidden because it is incompatible with gel or AGM type batteries. It may be authorized by parameter {14017}. The equalization can also be authorized depending on the setting of the DIP switch inside of the equipment (see chap. 9.1).

	<p>Caution: the equalization of open liquid electrolyte batteries (vented) produces highly explosive gas. The battery room and/or compartment must be adequately ventilated. Be careful: this charging phase may bring the batteries to voltage levels that can damage a sensitive load connected to the battery. Check that the connected loads are compatible with the highest voltage levels possible taking into account any compensation of the temperature sensor.</p> <p>A too long or frequent equalization phase can lead to an excessive consumption of electrolyte, a premature ageing or destruction of the battery. Follow scrupulously the instructions and recommendations of your battery supplier. Incorrect values which do not comply with the manufacturer's instructions can lead to a premature ageing and even the destruction of the batteries.</p>
---	--

For more information, contact your battery supplier who will inform you on the values to be applied for their products.

7.2.5 Temperature compensation

If a BTS-01 or BSP-500/1200 temperature sensor is used, the voltage adjustment thresholds for charging the battery (absorption, equalization, floating...) are automatically corrected in real time according to the battery temperature.

The value of this compensation in mV/°C/cell for a reference temperature of 25°C is set by parameter {14035} to -3mV/°C/cell. For example: for a 48V battery (24 cells of 2V) at a temperature of 30°C, the voltage compensation is: $(30-25)*24*(-3/1000) = -0.36V$. For a floating voltage value {14005} set to 54.4V the effective floating voltage (compensated) will be 54.0V.

7.3 DEFAULT BATTERY CHARGE CYCLE (ORIGINAL SETTINGS)

The charge cycle set by default does not allow the equalization phase and carries out only phase 1 (bulk), 2 (absorption) and 4 (floating) as per the figure to the right.

These factory parameter values of the VarioString are adapted to open lead-acid batteries, with no equalization, with an absorption voltage of 57,6V for 2h and a floating voltage of 54.4V (equivalent to the "off" position of the DIP switches n° 2, 3 and 4 when the VarioString is configured using the internal DIP switch).

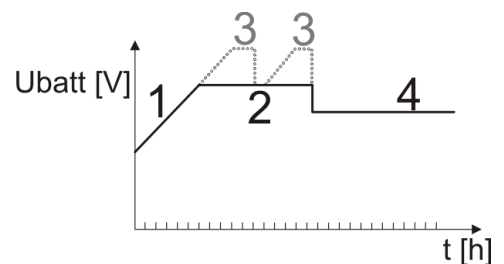

7.4 RECOVERY AFTER DEEP DISCHARGE

If the batteries are subjected to a deep discharge, the VarioString is capable of recharging them as long as the battery voltage is above 18V. The recharge battery current is limited to 40A until the battery voltage reaches 38V. Then, the VarioString can work at full power.

8 REMOTE ENTRY (AVAILABLE AS FROM SOFTWARE VERSION 1.5.22)

The VarioString has one remote entry that can be assigned to a function and programmed with the remote control RCC-02/-03. By default, no function is defined for the remote entry.

The cabling of the remote entry is done at the terminals (12). The jumpers (13) should be positioned correctly in function of the desired configuration according to the figures below.

Control by dry contact: the jumpers remain in their original position (1) A1-2 and B2-3.

Contact by a voltage (max. 60V eff. / 30mA): the jumpers are set as in (2) A1-B1 and A2-B2.

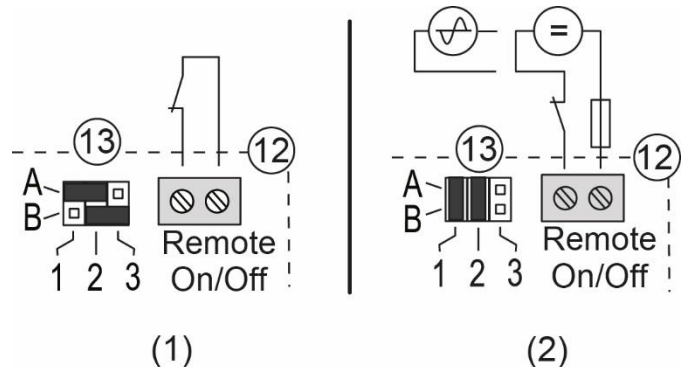

9 CONFIGURING THE VARIOSTRING(S)

The VarioString can be configured simply, allowing charge behaviours that meet perfectly the requirements of most lead-acid batteries. This configuration can be carried out using the DIP switches (10) inside of the equipment to set the various configurations according to the position of each DIP switch.

Before opening the VarioTrack, it is absolutely mandatory to disconnect all DC sources (battery and PV) from the equipment to avoid any danger. After disconnection, it is necessary to **wait at least 5 minutes before opening the equipment**, in order to guarantee that dangerous internal residual voltages have disappeared.

It is also possible to make configurations specific to particular requirements of the system thanks to the remote control RCC-02/03 described in the following chapter.

If an Xtender inverter/charger is interconnected (communication) to a VarioString, the Xtender battery cycle will be imposed to the VarioString of the system. This function may be disabled by parameter {14036}. If no Xtender is connected to the VarioString, the latter uses its own setting. In the case of an installation with several VarioStrings, the battery cycle is also automatically synchronized.

9.1 CONFIGURING THE EQUIPMENT BY MEANS OF THE INTERNAL DIP SWITCHES

Basic settings of the device can be entered manually with the aid of the DIP switch. This setting is only possible if the parameter {14174} permits it. This parameter is authorised by default. The following table provides an overview of the functions associated with each position of the DIP switch.

Position		Function
VS-70	VS-120	
1		Activation of DIP switch (of authorized by {14174})
2 to 4		Configuration of battery cycle
5 to 8	5 to 6	Reserved
-	7 to 8	Configuration of cabling of PV modules

Priority of DIP switch

	<p>The DIP switch parameter settings are prioritized over the parameter settings of the RCC. Therefore, if the parameter {14174} authorizes the use of the DIP switch and the position 1 of the DIP switch is activated (in ON position), the DIP switch will have priority over the parameter settings in the RCC. In this case, the following RCC parameter values will not be taken into account:</p> <ul style="list-style-type: none"> • Parameter related to the cabling of the PV modules {14002} (only VS-120) • Parameters related to the battery cycle {14005}, {14009}, {14021}, {14017}, {14024}, {14008}, {14011}, {14023} <p>On the contrary, if the DIP switch is not activated (position 1 of the DIP switch is off or parameter {14174} prohibits the utilisation of the DIP switch, the parameters of the RCC related to cabling of the PV modules and the battery cycle will be utilized.</p>
---	--

DIP switch 1 allows activating the settings defined by the DIP switch bank. This activation will not be taken into account if the parameter {14174} does not allow it. When the settings defined by the DIP switch bank are not activated, the default parameters (see list in chap.16) are applied. These parameters can be modified by means of the remote control RCC-02/03.

	<p>If the default parameters (factory settings) are modified, the new values must be reported in the parameter table in chap. 16 at the end of the manual which must remain on the installation site at the disposal of the maintenance personnel.</p>
---	--

Pos. n°1	Function
OFF	DIP switches not taken into account. Default parameters, or those set by the remote control RCC-02/03 are active.
ON	DIP switches are taken into account if authorized by {14174}

DIP switches 2, 3 and 4 allow the battery cycle to be modified as per the table below in order to adapt it to the various types of most common lead-acid batteries. The following values are for a 48V system.

Pos n°			Battery type	Floating voltage	Absorption voltage/period	Equalization (30min)
2	3	4				
OFF	OFF	OFF	Open	54.4V	57.6V / 2h	No
ON	OFF	OFF	Sealed w/short abs.	54.4V	57.6V / 1h	No
OFF	ON	OFF	GEL	55.2V	56.8 / 2h	No
ON	ON	OFF	AGM	53.6V	57.2V / 2h	No
OFF	OFF	ON	Sealed w/o abs.	54.4V	No	No
ON	OFF	ON	Open + equalization	54.4V	57.6V / 2h	63.2 V - 1/ 20 days + manual
OFF	ON	ON	Open + manual equalization	54.4V	57.6V / 2h	63.2 V + manual
ON	ON	ON	Open - reduced voltage	53.6V	57.2V / 2h	63.2 V - 1/ 20 days + manual

	<p>If a VarioString is interconnected (communication) to an Xtender inverter/charger, the VarioString battery cycle will be automatically synchronized with the cycle of the Xtender in the system. This function may be disabled by parameter {14036}.</p>
---	---

	<p>When several VarioStrings are interconnected (communication) and linked to the same battery, differences in production (power) are normal, especially in the following cases:</p> <ul style="list-style-type: none"> • The units are in voltage regulation phase (absorption, equalization, floating), and in this case the current distribution may be very uneven. This situation is normal and has no influence on the system efficiency. • The equipment is in a bulk phase; in this case the difference is due to the difference in size, orientation, cleanness, shade or any other situation that may influence the production capacity of the solar generator. This situation may require the generator to be checked in order to clear/remedy the possible fault.
---	---

DIP switches 5 and 6, reserved.

For the VS-120 the DIP switches 7 and 8 allow the definition of the topology of the PV module connections, which can be done in 3 different ways on the VarioString VS-120: independent (each string of PV modules connected to one VarioString PV input), in series or in parallel. With the automatic position, the VarioString VS-120 will determine itself the connection topology. In this case, the VarioString VS-120 will perform a cabling test when it detects a voltage at both the PV inputs. Or, if a voltage at only 1 PV input is detected, the test begins after 15 minutes. The automatic detection requires a certain power level to be available. In the case of system commissioning at night or with a very low insolation, the test will be postponed until the necessary conditions are present.

Pos n°		Connection mode of the MPPT inputs
7	8	
OFF	OFF	Automatic
ON	OFF	MPPTs independents
OFF	ON	MPPTs in series
ON	ON	MPPTs in parallel

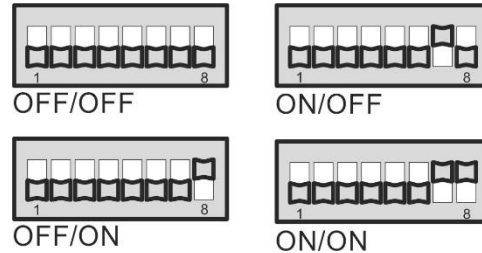

Connection of multiple VarioString

When several VarioStrings are interconnected by the communication bus and to the same battery, if the DIP switch is used, it is imperative that the DIP switch settings are consistent among the VarioString. The following table shows which DIP switch positions should be identical when more than one VarioString is connected together.

Position		Function	Constraint if multiple VarioStrings
VS-70	VS-120		
1		Activation of DIP switch (of authorized by {14174})	Identical for all
2 to 4		Configuration of battery cycle	Identical for all
5 to 8	5 à 6	Reserved	-
-	7 to 8	Configuration of cabling of PV modules	Can be different

Only the configuration of the cabling of the MPPT inputs can be different from one VarioString to another. The battery charge cycle should be configured the same (one common battery for all the VarioStrings). The battery charge cycle will therefore be automatically synchronized in all the devices.

Blockage of the DIP switch

Settings defined by the position of the DIP switches may be inhibited (disabled) with parameter {14174} using the remote control RCC-02/03. The VarioString's operation will then be defined only by the parameter values set by default or by the RCC remote control.

9.2 DISPLAYING THE EQUIPMENT STATUS USING THE REMOTE CONTROL RCC-02/03

9.2.1 Displaying the status of a single unit system

The VarioString screen allows displaying six values in real time. Four values (a) can be chosen among many measured and calculated values indicated in the table below and two show the status of the auxiliary contacts (b) (these fields are visible even if an ARM-02 is not present).

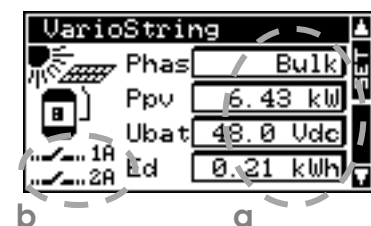

9.2.1.1 Choosing the displayed values

To choose which values to display, press the SET button to enter the first field which will appear with a black background.

To modify the field content, use the SET button; then by using the arrows, consult the various displayable values and select them as permanently displayable values in the related field by validating with the SET button.

When no other value than the one initially displayed in the field is selected, ESC key validates the initial choice.

The four fields can be scrolled and modified any time to display four of the values indicated in the table below. Some parameters are not available depend the model.

Nr	Name	Unit	VarioString information description
15000	Ubat	Vdc	Battery voltage
15001	Ibat	Adc	Battery current
15002	Phas	Text	Battery cycle phase (Bulk, Absorpt., Equalize, Floating, ---, ---, R.float., Per.abs., ---, ---, ---, ---)
15003*	conf	Text	PV type of wiring (Unknown, Independ., Series, Parallel, Error)
15004*	Upv	Vdc	PV voltage
15005*	Upv1	Vdc	PV1 voltage
15006*	Upv2	Vdc	PV2 voltage
15007*	Ipv	Adc	PV current
15008*	Ipv1	Adc	PV1 current
15009*	Ipv2	Adc	PV2 current
15010	Ppv	kW	PV power
15011*	Ppv1	kW	PV1 power
15012*	Ppv2	kW	PV2 power
15013*	Mode	Text	PV operating mode (Night, Security, OFF, Charge, ChargeV, Charge I, ChargeP, Chargelpv, ChargeT, ---, Ch.lbsp)
15014*	Mod1	Text	PV1 operating mode (Night, Security, OFF, Charge, ChargeV, Charge I, ChargeP, Chargelpv, ChargeT, ---, Ch.lbsp)
15015*	Mod2	Text	PV2 operating mode (Night, Security, OFF, Charge, ChargeV, Charge I, ChargeP, Chargelpv, ChargeT, ---, Ch.lbsp)
15016	Cd	Ah	Production PV in (Ah) for the current day
15017	Ed	kWh	Production PV in (kWh) for the current day
15018*	Ed1	kWh	Production PV1 in (kWh) for the current day
15019*	Ed2	kWh	Production PV2 in (kWh) for the current day
15020	kWhR	kWh	Produced PV energy resettable counter
15021*	kWh1	kWh	Produced PV1 energy resettable counter
15022*	kWh2	kWh	Produced PV2 energy resettable counter
15023	MWhT	MWh	Total PV produced energy
15024*	MWh1	MWh	Total PV1 produced energy
15025*	MWh2	MWh	Total PV2 produced energy
15026	Cd-1	Ah	Production PV in (Ah) for the previous day
15027	Ed-	kWh	Production PV in (Wh) for the previous day
15028*	Ed1-	kWh	Production PV1 in (Wh) for the previous day
15029*	Ed2-	kWh	Production PV2 in (Wh) for the previous day
15030*	Sd	h	Number of irradiation hours for the current day
15031*	Sd-1	h	Number of irradiation hours for the previous day
15032	Tbat	°C	Battery temperature
15033*	Upmx	Vdc	Max PV voltage for the current day
15034*	Upm1	Vdc	Max PV1 voltage for the current day
15035*	Upm2	Vdc	Max PV2 voltage for the current day
15036*	Ibmx	Adc	Max battery current of the current day
15037*	Ppmx	kW	Max PV power for the current day
15038*	Ppm1	kW	Max PV1 power for the current day
15039*	Ppm2	kW	Max PV2 power for the current day
15040*	UbmX	Vdc	Max battery voltage for the current day
15041*	UbmN	Vdc	Min battery voltage for the current day
15042	TabS	h	Time in absorption of the current day

Nr	Name	Unit	VarioString information description
15049*	Err	Text	Type of error (None, OverV_B, OverV_PV, OverV_PV1, OverV_PV2, OverI_PV, OverI_PV1, OverI_PV2, GroundBat, GroundPV, GroundPV1, GroundPV2, OverTemp, UnderV_B, Cabling, Other)
15050	Sync	Text	Synchronized with Xtender battery cycle (No, Yes)
15051	Sync	Text	Synchronisation state (---, ---, ---, ---, XTslave, VTslave, ---, ---, VTmaster, Autonom, VSslave, VSmaster)
15052*	EqIn	days	Number of days before next equalization
15053*	Bset	Vdc	Battery set point
15108	VS state	Text	State of the VarioString (Off, On)
15109	locEr		Local daily communication error counter (CAN)
15111	RME	Text	Remote entry state (RM EN 0, RM EN 1)

*Some values can't be displayed in the multi-unit display. They will be visible while going in the sub-screen of the Multi-unit display, showing every unit individually.

9.2.1.2 Displaying the triggering source of the auxiliary relays

To view the actual triggering source of the two auxiliary relays, press the SET button and use the up/down arrows to navigate down to the two relay fields (b). Select one of the two relays and press SET to view the information indicating the cause of the last relay activation (if the relay is presently activated) or deactivation (if the relay is presently deactivated). The display also shows the logic combination mode: AND or OR.

To exit the selected relay field, press ESC.

	These information fields are visible even if the auxiliary relay ARM-02 (see chapter 10.3), is not connected.
---	---

9.2.2 Displaying the operating mode of the equipment (Info n° 15013,15014,15015)

Night: the solar generator voltage (or luminous intensity) is not enough to start the equipment. When this indication appears during the day, it means a generator fault (wiring).

Charge: the charger operates normally at the maximum power point of the solar generator.

Charge U: the VarioString operates in voltage regulation (absorption, equalization, or floating). In this status, it is normal to see a current lower than the maximum possible.

Charge I: the VarioString has reached the maximum allowed current fixed by the parameter {14001} "battery charge current". In this status, the power of the generator is limited to a lower value than the maximum possible.

Charge T: the maximum permissible temperature of the VarioString is reached and the power is limited by the temperature. This status is not a problem but may highlight that the system performances could be enhanced by reducing ambient temperature.

Charge P: the max power of the VarioString is reached (7000W). This mode is also shown if one of the two MPPT inputs reaches its maximum power in independent mode (3500W).

Charge Ipv: the max current is reached for one of the two MPPT inputs (13A).

Security: the equipment turns off due to a fault normally indicated by a message on the RCC or by the "error" indicator (3) on the equipment.

OFF: the equipment is manually turned off by the operator or using a remote control.

9.2.3 Displaying security errors (Info n° 15049)

When a security error occurs, the device will stop functioning. A short text, limited to 8 characters, will appear on the display indicating which kind of error it is.

Text	Description
None	No error. The unit is fully functional
GroundBat	The battery grounding mode is different from that chosen in the parameter settings (chap. 4.4.1.)
GroundPV	The PV grounding in parallel or series mode is different from that chosen in the parameter settings (chap. 4.4.1).
GroundPV1*	The grounding of the MPPT input PV1 is different from that chosen in the parameter settings (chap. 4.4.1).
GroundPV2*	The grounding of the MPPT input PV2 is different from that chosen in the parameter settings (chap. 4.4.1).
OverTemp	An abnormal high temperature is detected (Alarm 014).
OverV_B	A battery voltage higher than 68V has been detected (alarm 20).
UnderV_B	The battery voltage is too low to start the charger.
OverI_PV	A PV voltage over 600V has been detected (on VS-70 or on VS-120 in parallel mode), or over 900V (VS-120 in series mode) (alarm 82).
OverI_PV1*	A PV voltage over 600V has been detected in the MPPT input PV1.
OverI_PV2*	A PV voltage over 600V has been detected in the MPPT input PV2.
OverV_PV	The max input current has been exceeded (series or parallel cabling).
OverV_PV1*	The max input current has been exceeded in PV1.
OverV_PV2*	The max input current has been exceeded in PV2.
Cabling*	A cabling error has been detected on the PV inputs or the cabling does not correspond to the selected mode (chap 4.4.1).

* For VS-120 only

9.2.4 Displaying the values of a multi-unit system

When several VarioString units are connected to the remote control RCC-02/03, the screen VarioString MULTI appears, displaying the consolidated values for all the connected equipment. The displayed values can be selected

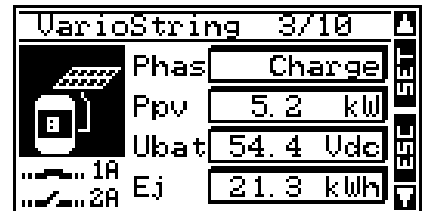
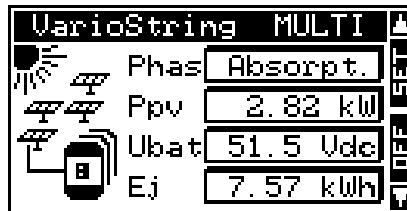

as per the same procedure described in chap. 9.2.1.1. Moreover, the units can be viewed one by one by using the arrows up/down after the SET button (2x) when the VarioString image is with a black background.

9.2.5 Displaying messages and event history

The message system is the same as for an Xtender inverter/charger or a VarioTrack MPPT solar charge controller and the alarm messages/information are stored and displayed in the same list. See the RCC remote control user manual.

9.2.5.1 Message list

Warning (000): Battery low: the battery voltage is lower than 40V for more than 30 seconds. The VarioString continues to work until the battery voltage falls below 18V.

Message (012): Use of battery temperature sensor: this indication is given only if the sensor is connected to the VarioString when it is energized.

Halted (014): Over temperature EL: the warmest point inside the equipment has exceeded the allowed highest temperature. The equipment stops operating. It starts again when the temperature drops back to a normal value.

Halted (020): Battery overvoltage: the battery voltage is higher than 68V. The VarioString turns off. It starts again when the voltage returns to a normal value.

Warning (081): Earthing fault: the battery earthing does not (anymore) match the selection made by parameters {14040}, {14041} and {14042} which establishes the type of earthing to be checked.

Halted (082): PV overvoltage: the solar generator has a voltage higher than 600V (parallel or independent connection) or higher than 900V (series connection).

Message (083), (170), (171): No solar production in the last 48h: no PV voltage has been detected for 48h. The PV generator has probably been disconnected. Check the protection devices (fuse or circuit breaker) and/or check the wiring.

Message (084): Equalization performed: indicates the end of the equalization cycle.

9.3 CONFIGURING THE VARIOSTRING USING THE REMOTE CONTROL RCC-02/03

Many parameters are stored in the VarioString internal memory. When a parameter is modified using the remote control RCC-02/03 (hereafter referred to as RCC), it is sent to the VarioString and stored permanently.

If the RCC is removed from the system, this parameter continues to be used by the VarioString with this modified value. If the VarioString is disconnected and then connected again, the new value can be retrieved from the memory. This allows for example to pre-program a VarioString at the workshop and to supply it to a customer, ready for his specific application.

If the settings made using the DIP switches are disabled, either because the Pos 1=off or because the parameter disabling the DIP switches {14174} = yes, the VarioString uses its stored values. The parameters' factory values of the equipment are equivalent to the values set when all the DIP switches are in "OFF" position, i.e. adapted to an open battery, without equalization, with an absorption voltage of 57,6V during 2h and a floating voltage of 54,4V.

The parameter values can be modified using the RCC and are stored and applied by the VarioString.

	<p>When the remote control RCC is connected to the VarioString by the communication bus it is possible that the software versions are not compatible. It is highly recommended to update the software of all components in the system in order to guarantee all functionalities. Therefore, before starting the setup of the device, download the latest software version from our website: www.studer-innotec.com on an SD card. Follow the instructions in the RCC manual for a successful installation.</p>
---	--

9.3.1 The real time clock

The VarioString features a real time clock that allows among others to have a correct date and hour for the RCC records. This clock must be set using the remote control RCC-02/03. Thanks to an internal battery, this setting is retained even when the equipment is disconnected from its voltage source (battery or PV).

9.4 DESCRIPTION OF THE VARIOSTRING PARAMETERS

The parameters of the VarioString can be modified in the menu "VarioString MPPT setting" of the RCC remote control.

This menu allows accessing the following 4 sub-menus:

BASIC SETTINGS: contains the most common parameters to be set at commissioning.

BATTERY MANAGEMENT AND CYCLE: contains all parameters related to defining in detail the battery cycle during all its phases.

SYSTEM: contains parameters related to the back up and restoring of the system, resets, monitoring settings, etc.

AUXILIARY CONTACTS: contains parameters related to the auxiliary relays (optional accessory ARM-02).

9.4.1 Convention

Functions and values of the parameters mentioned in this manual are described in this chapter. Each parameter is defined by a short description, a number {xxxxx} followed by its value and unit by default (xxxxx). The type of parameter (menu, signal) replaces the value between brackets when this latter does not exist. The RCC menus are also identified by a name and a number {xxxxx} that can be found, as per the parameter number, on the top right-hand corner of the RCC screen.

9.4.2 Parameter access level

All described parameters are accessible through 2 different access levels, "Basic" and "Expert". When using the factory configuration, only a few parameters are accessible at "Basic" level.

To access the other menus and parameters, the RCC's configuration must be set to "Expert" level. How to change the user level is indicated in the RCC user manual, chapter "User level".

The parameters in grey "Installer" are accessible only by qualified personnel.

9.4.3 Organisation of the VarioString configuration menu

Level	Nr	VarioString parameter description	Factory value
Basic	14000	BASIC SETTINGS	
Expert	14174	Block manual programming (dip-switch)	No
Expert	14001	Battery charge current (VS-120)	120 Adc
Expert	14217	Battery charge current (VS-70)	70 Adc
Basic	14002	Configuration of PV modules (VS-120)	Automatic
Basic	14067	Restore default settings	-
Inst.	14068	Restore factory settings	-
Expert	14003	BATTERY MANAGEMENT AND CYCLE	
Basic	14036	Synchronisation battery cycle with Xtender	Yes
Expert	14001	Battery charge current (VS-120)	120 Adc
Expert	14217	Battery charge current (VS-70)	70 Adc
Expert	14216	Battery undervoltage	40 Vdc
Expert	14035	Temperature compensation	-3 mV/°C/cell
Expert	14004	Floating phase	
Expert	14005	Floating voltage	54.4 Vdc
Expert	14006	Force phase of floating	-
Expert	14007	Absorption phase	
Expert	14008	Absorption phase allowed	Yes
Expert	14009	Absorption voltage	57.6 Vdc
Expert	14010	Force absorption phase	-
Expert	14011	Absorption duration	120 min
Expert	14012	End of absorption triggered by the current	No
Expert	14013	Current threshold to end absorption phase	10 Adc
Expert	14016	Equalization phase	
Expert	14017	Equalization allowed	No
Expert	14018	Force equalization	-
Expert	14021	Equalization voltage	62.4 Vdc
Expert	14020	Equalization current	80 Adc
Expert	14022	Equalization duration	30 min
Expert	14023	Equalization with fixed interval	Yes
Expert	14024	Days between equalizations	26 days
Expert	14025	End of equalization triggered by the current	No
Expert	14026	Current threshold to end equalization phase	10 Adc
Expert	14019	Equalization before absorption phase	Yes
Expert	14027	New cycle	
Expert	14028	Force a new cycle	-
Expert	14029	Voltage level 1 to start a new cycle	48.8 Vdc
Expert	14030	Time period under voltage level 1 to start a new cycle	30 min
Expert	14031	Voltage level 2 to start a new cycle	47.2 Vdc
Expert	14032	Time period under voltage level 2 to start a new cycle	2 min
Expert	14033	Cycling restricted	Yes
Expert	14034	Minimal delay between cycles	1 hours

Level	Nr	VarioString parameter description	Factory value
Expert	14065	Battery overvoltage level	68.2 Vdc
Expert	14066	Restart voltage level after a battery overvoltage	64.8 Vdc
Expert	14037	SYSTEM	
Expert	14174	Block manual programming (dip-switch)	No
Expert	14040	Type of battery grounding	No control
Expert	14194	Configuration for VS-120	
Expert	14041	Type of PV grounding	No control
Expert	14175	Type of PV1 grounding	No control
Expert	14042	Type of PV2 grounding	No control
Expert	14180	Type of MPPT algorithm	
Expert	14043	Type of MPP tracking algorithm PV	LSF
Expert	14044	PV voltage fixed (for PV in series)	700 Vdc
Expert	14179	PV voltage fixed (for PV in //)	500 Vdc
Expert	14045	Ratio of PV open circuit voltage	0.7
Expert	14176	Type of MPP tracking algorithm PV1	LSF
Expert	14177	PV1 voltage fixed	500 Vdc
Expert	14178	Ratio of PV1 open circuit voltage	0.7
Expert	14046	Type of MPP tracking algorithm PV2	LSF
Expert	14047	PV2 voltage fixed	500 Vdc
Expert	14048	Ratio of PV2 open circuit voltage	0.7
Inst.	14192	Establishment time (Algo MPPT)	0 sec
Inst.	14193	Averaging time (Algo MPPT)	0 sec
Inst.	14190	PV wiring type erased from memory	-
Expert	14195	Configuration for VS-70	
Expert	14196	Type of PV grounding	No control
Expert	14180	Type of MPPT algorithm	
Expert	14197	Type of MPP tracking algorithm PV	LSF
Expert	14198	PV voltage fixed	500 Vdc
Expert	14199	Ratio of PV open circuit voltage	0.7
Inst.	14192	Establishment time (Algo MPPT)	0 sec
Inst.	14193	Averaging time (Algo MPPT)	0 sec
Expert	14200	Remote entry (Remote ON/OFF)	
Expert	14201	Remote entry active	Open
Expert	14202	ON/OFF command	No
Expert	14203	Activated by AUX1 state	No
Expert	14204	Start equalization	No
Expert	14205	Send a message when remote entry changes state	No
Inst.	14218	VarioString watchdog enabled (SCOM)	No
Inst.	14219	VarioString watchdog delay (SCOM)	60 sec
Expert	14182	Reset PV energy meter	-
Expert	14051	Reset daily solar production meters	-
Expert	14052	Reset daily min-max	-
Basic	14067	Restore default settings	-
Inst.	14068	Restore factory settings	-
Inst.	14069	Parameters saved in flash memory	Yes
Expert	14038	ON of the VarioString	-
Expert	14039	OFF of the VarioString	-
Expert	14059	Reset of all VarioString	-

9.4.3.1 Auxiliary relay parameters

A list of the auxiliary relay parameters can be found at the end of this manual in chapters 9.4.7 and 17.

9.4.4 Basic settings {14000}

9.4.4.1 Block manual programming (DIP switch) {14174} (No)

Blocks the operating mode chosen by means of the DIP switches inside the VarioString.

9.4.4.2 Battery charge current (VS-120) {14001} &

9.4.4.3 Battery charge current (VS-70) {14217}

The VarioString tries to maximize the battery charging current up to its rated current; however, it is possible to limit this current using this parameter for small capacity batteries. The current appropriate to the battery is reported in its technical data. The value set by this parameter is used during the bulk phase.

9.4.4.4 Configuration of PV modules {14002} (Automatic)

This parameter allows the selection of the type of cabling of the MPPT inputs on the VarioString VS-120. In automatic mode, the VarioString VS-120 makes measurements to determine the type of connection. You can also select independent mode if you have two distinct PV strings that are not connected together. The parallel cabling mode is reserved for the case when your PV string(s) are brought to the VarioString with one set of cables and the two MPPT inputs on the VarioString are physically connected (cabling accessories are available). The series cabling mode is used for PV strings with max voltage levels higher than 600V; in which case the PV generator is connected to PV2- and PV1+, and PV2+ and PV1- are physically bridged.

9.4.4.5 Restore default settings {14067}

Sending this signal restores the original values of the VarioString parameters.

	If the installer has made some adjustments during the commissioning of the installation, this function does not restore the factory settings but those made by the installer.
---	---

9.4.4.6 INSTALLER: Restore factory settings {14068}

This parameter is accessible only when the RCC-02/03 is in installer level and allows the VarioString parameters to be restored to factory settings.

9.4.5 Battery management and cycle {14003}

The VarioString battery charger is designed to ensure a battery charge as complete as possible. The charge process, described in detail in chapter 7.2 is managed in 4 successive phases of which only 3 are activated by default. Thus the VarioString will carry out only phases 1 (bulk), 2 (absorption) and 4 (floating) according to a charge profile as per the figure to the right which represents the basic cycle. This basic cycle takes place automatically.

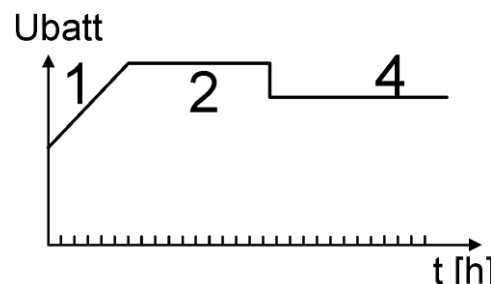

The charge curve obtained this way depends on a whole series of parameters that may be freely modified in order to get a charge profile that meets at best the requirements set by the manufacturer or the user.

If the BTS-01 temperature sensor (or the BSP, battery status processor) is used, the voltage regulation thresholds of the battery are corrected in real time according to the battery temperature. The value of this compensation in mV/°C/cell for a reference temperature of 25°C is set by parameter {14035} to -3mV/°C/cell.

	The battery setting is carried out under the responsibility of the operator. An incorrect setting that does not meet the battery charging methods recommended by the manufacturer may be dangerous and/or considerably reduce the battery service life. If the factory settings are modified, the new values must be entered in the parameter table at the end of this manual.
---	--

9.4.5.1 Synchronisation battery cycle with Xtender {14036} (yes)

When a Studer inverter of the range Xtender is used in the system, it can transfer to the VarioTrack its battery charge setting so that they can operate together in an optimum way. Synchronization allows a coherent operation of multiple units which participate to the battery charging and avoids multiple successive equalizations triggered by each charger.



When this parameter {14036} is activated, all other parameter involved in the battery cycle are hidden and not accessible. In this case, only the maximum charging current is adjustable.

9.4.5.2 Battery charge current (120 Adc) {14001}

See Basic Settings, chap. 9.4.4.2.

9.4.5.3 Battery charge current (VS-70) {14217}

See Basic Settings, chap. 9.4.4.2.

9.4.5.4 Battery under-voltage {14216}

This parameter sets the undervoltage level of the battery. In case of battery undervoltage, the red LED will blink 1x, a message is sent to the RCC and an event based on this undervoltage can be programmed on the auxiliary relays.

9.4.5.5 Temperature compensation {14035} (-3mV/°C/cell)

If a BTS-01 or BSP temperature sensor is used, the voltage adjustment thresholds for charging the battery (absorption, equalization, floating...) are automatically corrected in real time according to the battery temperature. The value of this compensation in mV/°C/cell for a reference temperature of 25°C is set by parameter {14035} to -3mV/°C/cell. For example: for a 48V battery (24 cells of 2V) at a temperature of 30°C, the voltage compensation is: $(30-25)*24*(-3/1000) = -0.36V$. For a floating voltage value {14005} set to 54.4V the effective floating voltage (compensated) will be 54.04V.

9.4.5.6 Floating phase {14004}

9.4.5.6.1 Floating voltage {14005} (54.4 Vdc)

Determines the voltage applied when the battery is fully charged. This voltage prevents self-discharge and keeps the battery to its optimum charge level.

9.4.5.6.2 Force phase of floating {14006}

This parameter may be used to force a battery cycle in progress to assume the final values of the floating voltage phase. If the battery voltage level is higher, the charger momentarily switches out until the new target voltage is reached.

9.4.5.7 Absorption phase {14007}

During this phase, the battery accumulates the last percentages of power to be stored. This phase takes place at a constant voltage. Over the course of this phase, the necessary current diminishes progressively. Therefore, the VarioString does not work at the optimal point of the PV generator because all the available PV power is not required.

9.4.5.7.1 Absorption phase allowed {14008} (yes)

This parameter determines whether the absorption phase is carried out or not. When this phase is disabled, the charger goes directly to the following authorized phase (equalization, but most often a floating phase).

9.4.5.7.2 Absorption voltage {14009} (57.6 Vdc)

Defines the applied voltage during absorption phase.

9.4.5.7.3 Force absorption phase {14010} (signal)

This signal starts again an absorption phase from the floating phase. The charge indicator (2) flashes 2x indicating that the equalization phase is on-going.

9.4.5.7.4 Absorption duration {14011} (120 min)

Use this parameter to set the absorption duration. The absorption phase starts once the set voltage {14009} is reached. When the time is over (see chap. 7.2.2), the charger goes automatically to the following authorized phase.

9.4.5.7.5 End of the absorption triggered by the current {14012} (no)

The absorption phase can be interrupted when the battery charging current goes under a certain threshold, at which point the charger automatically passes to the next authorized phase. This can be used in order to shorten the period under which a high voltage is applied and thus reduce water consumption.

9.4.5.7.6 Current threshold to end absorption phase {14013} (10 Adc)

Progressively, during the absorption phase, the charging current decreases naturally. If the bulk phase has been carried out with a current appropriate for the battery, it is not necessary to wait for a certain period to finish charging. The absorption phase can be interrupted if the battery charge current falls below a certain level.

This parameter sets the current under which the absorption phase is considered finished. When the charger current goes below this value, the next phase (most often the floating phase) starts. If the production of the PV generator is insufficient to keep the voltage, this current is not taken into account and the absorption phase goes on.

9.4.5.8 Equalization phase {14016}

Some types of battery need equalization in order to avoid the stratification of the water and acid they contain. Use the parameters hereafter to set the operating conditions of this charging phase as described in chap. 7.2.4.

	<p>During an equalization phase, an emission of a highly explosive gas occurs (hydrogen/oxygen). Follow carefully all the instructions of the battery manufacturer regarding this phase. In any case, make sure that the battery room is adequately ventilated. Equalization reduces the battery water level: check it regularly.</p>
---	---

9.4.5.8.1 Equalization allowed {14017} (no)

Determines whether the equalization phase (triggered manually or automatically) is allowed or not.

9.4.5.8.2 Force equalization {14018}

Use this parameter to manually start the equalization phase. It is only possible to force an equalization phase when it is authorized by {14017}.

	<p>Once equalization phase is initiated, disabling the phase does not stop the equalization. To stop the equalization, force the transition into floating {14006}, absorption {14010} or a new cycle {14028}. It is also possible to interrupt the equalization by pressing the "SET" button for more than 2 seconds (procedure described in chap. 6.1).</p>
---	--

9.4.5.8.3 Equalization voltage {14021} (62.4 Vdc)

This parameter determines the maximum voltage during the equalization phase.

	<p>This voltage is corrected by the temperature compensation factor {14035} if a temperature sensor (BTS-01 or BSP) is installed in the system.</p>
---	---

9.4.5.8.4 Equalization current {14020} (80 Adc)

The equalization phase can be carried out with a limited current that can be adjusted using this parameter. In any case, the current does not exceed the bulk current {14001}. As a rule, the limited charging current is used only if the equalization is started at the end of the absorption phase.

9.4.5.8.5 Equalization duration {14022} (30 min)

This parameter determines the equalization period. The equalization phase starts as soon as the set battery voltage exceeds the absorption voltage. When the period has elapsed, the charger goes automatically to the following authorized phase. If the voltage cannot be kept (no sunshine, clouds...), the countdown is paused.

9.4.5.8.6 Equalization with fixed interval {14023} (yes)

When this parameter is activated (yes), the battery charge cycle with an active equalization phase starts at the interval specified by the following parameter {14024}.

9.4.5.8.7 Days between equalizations {14024} (26 days)

This parameter determines the number of days in between the equalizations. This counter is reset to zero when the equalization is activated manually.

 In the case of incomplete charging cycles (for example when charging with solar generators), this function is useful also to limit the repetition of the equalization cycles. When the number of days is reached, a new cycle is not initiated automatically. The equalization will take place during the following charge cycle.

9.4.5.8.8 End of the equalization triggered by the current {14025} (no)

Progressively, during the equalization phase, the charging current decreases naturally. If the bulk phase has been carried out with a current appropriate for the battery, it is not necessary to wait for a certain period to finish charging. The equalization phase can be interrupted when the battery charging current goes under a certain threshold. This can be used in order to reduce the equalization duration and the electrolysis phenomenon related to it.

9.4.5.8.9 Current threshold to end equalization phase {14026} (10 Adc)

This parameter determines at which current the equalization phase is considered finished. The next phase starts, when the charger current goes below this value.

9.4.5.8.10 Equalization before absorption phase {14019} (yes)

This parameter determines if during the charge cycle the equalization will take place before or after the absorption phase. By default, the equalization phase is carried out before the absorption phase.

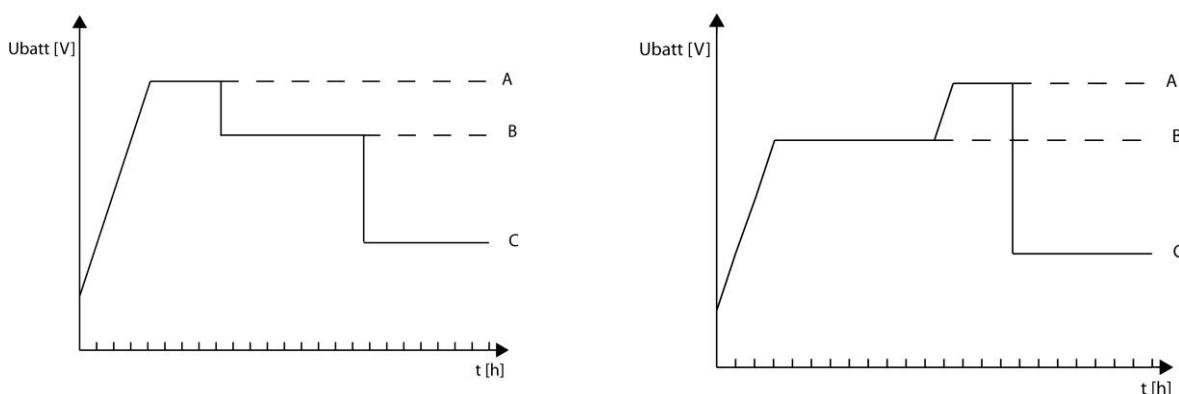

A= equalization voltage, B= absorption voltage, C= floating voltage

9.4.5.9 New cycle {14027}

Usually, batteries are charged during the day via the PV generator then partially discharged during the night by the user. The next day, a charge cycle starts again (bulk-absorption-floating). To start a new complete charge cycle the battery should be discharged below the conditions set by the parameters {14029} to {14034}. If these conditions have not been met because, for example, the installation has no users, a new absorption phase will not be necessary as this would lead to slight battery water consumption. In this case, the charge cycle is kept in floating phase.

9.4.5.9.1 Force a new cycle {14028}

This parameter enables to force manually a complete charge cycle. The VarioString switches immediately to the bulk phase.

9.4.5.9.2 Conditions for a new cycle

A new battery cycle will be triggered if one or the other 2 conditions, defined by a period of time during which the battery voltage is lower than a threshold, is met. These 2 voltages related to 2 durations are configurable. Usually a higher voltage is used for a longer duration and a lower voltage for a shorter duration.

Voltage level 1 to start a new cycle {14029} (48.8 Vdc)

Time period under voltage level 1 to start a new cycle {14030} (30 min)

Voltage level 2 to start a new cycle {14031} (47.2 Vdc)

Time period under voltage level 2 to start a new cycle {14032} (2 sec)

9.4.5.9.3 Cycling restricted {14033} (yes)

The repetition of the charge cycles can be limited establishing the minimum time between each cycle using parameter {14034}.

9.4.5.9.4 Minimal delay between cycles {14034} (1 hour)

Determines the minimum interval (time) between each cycle when parameter {14033} activates this function.



If the parameter {14033} is activated and the interval parameter {14034} is set to 24h, there will be only one charge cycle per day. In this case, if the conditions are met for a new cycle, it will not take place until the next day and the charger will keep the battery at floating voltage.

9.4.6 System {14037}

9.4.6.1 Block manual programming (DIP switch) {14174} (no)

See Basic Settings chap. 9.4.4.1.

9.4.6.2 Type of battery grounding {14040} (no control)

This parameter allows the VarioString to constantly verify the state of the battery grounding connection, if desired. In the event of an error, the VarioString will turn on a LED indicator light (3). It is possible to ground either of the battery terminals.

9.4.6.3 Configuration for VS-120 {14194}

9.4.6.3.1 Type of PV grounding {14041} (no control)

This parameter allows the VarioString to constantly verify the state of the PV grounding connection during its use in series or parallel mode. In the event of an error, the VarioString will turn on a LED indicator light (3). It is possible to ground either of the PV terminals.

9.4.6.3.2 Type of PV1 grounding {14175} (no control), Type of PV2 grounding {14042} (no control)

The same as the preceding parameter, but for the MPPT inputs PV1 and PV2 in independent mode on the VarioString VS-120.

9.4.6.4 Type of MPPT algorithm {14180}

9.4.6.4.1 Type of MPP tracking algorithm PV {14043} (P&O)

This parameter allows setting the type of algorithm used by the VarioString to establish its operating point in series or parallel cabling mode.

P&O: Maximum Power Point (MPP) search algorithm. This algorithm is fully automatic and searches the MPP of your system.

OC ratio: With this mode, the VarioString makes an open circuit voltage measurement once every 5 minutes and fixes the working voltage at a point proportional to the measurement. The measurement

lasts 2 seconds.

Ratio of PV open circuit voltage {14045} (0.7)

This parameter fixes the operating point according to the measured open circuit voltage. The measured open circuit voltage is multiplied by this ratio to calculate the operating point. (ex.: the measured open circuit voltage is 500V, Ratio 0.7, the operating point will be $500 \times 0.7 = 350V$).

Upv fixed: with this mode the VarioString fixes the PV operating voltage and it does not vary.

PV voltage fixed {14177} (500 Vdc)

PV voltage fixed (for PV in series, VS-120) {14044} (700 Vdc)

PV voltage fixed (for PV in parallel, VS-120) {14179} (500 Vdc)

These parameters allow setting the voltage value at which you wish to set the operating point.

LSF (least square fitting): Improved MPPT (maximal power point tracking) algorithm. This algorithm functions automatically and continuously searches for the optimal functioning of your system.

9.4.6.4.2 Type of MPP tracking algorithm PV1 {14176} (P&O) and Type of MPP tracking algorithm PV2 {14046} (P&O)

Same as the preceding parameter but for when the PV1 and PV2 inputs are used independently on the VarioString VS-120.

9.4.6.5 PV wiring type erased from memory {14190}

This parameter resets the type of PV wiring detected by the VarioString.

9.4.6.6 Configuration for VS-70 {14195}

9.4.6.6.1 Type of PV grounding {14196} (no control)

This parameter allows the VarioString to constantly verify the state of the PV grounding connection during its use in series or parallel mode. In the event of an error, the VarioString will turn on a LED indicator light (3). It is possible to ground either of the PV terminals.

9.4.6.6.2 Type of MPP tracking algorithm PV {14197} (P&O)

This parameter allows setting the type of algorithm used by the VarioString to establish its operating point.

P&O: Maximum Power Point (MPP) search algorithm. This algorithm is fully automatic and searches the MPP of your system.

OC ratio: With this mode, the VarioString makes an open circuit voltage measurement once every 5 minutes and fixes the working voltage at a point proportional to the measurement. The measurement lasts 2 seconds.

Ratio of PV open circuit voltage {14199} (0.7)

This parameter fixes the operating point according to the measured open circuit voltage. The measured open circuit voltage is multiplied by this ratio to calculate the operating point. (ex.: the measured open circuit voltage is 500V, Ratio 0.7, the operating point will be $500 \times 0.7 = 350V$).

Upv fixed: with this mode the VarioString fixes the PV operating voltage and it does not vary.

PV voltage fixed {14198} (500 Vdc)

These parameters allow setting the voltage value at which you wish to set the operating point.

LSF: Improved MPPT (maximal power point tracking) algorithm. This algorithm functions automatically and continuously searches for the optimal functioning of your system.

9.4.6.7 Remote entry (Remote ON/OFF) {14200}

9.4.6.7.1 Remote entry active {14201}

With this parameter it is possible to define if the remote entry is active "open", "closed" or on "rising edge".

In mode "open" or "closed" the chosen parameter's function will take place once the remote entry is

active. The function opposite to the parameter will be carried out when the remote entry is inactive.

In mode "rising edge" the standby state is an open contact. When a voltage pulse is applied, the function of the chosen parameter takes place. The voltage pulse must be at least 200ms and at the most 2s. By applying a second pulse the opposite function of the chosen parameter will take place.

9.4.6.7.2 ON/OFF command {14202}

When this parameter is activated, an active remote entry turns on the VS and an inactive remote entry turns off the VS. When this parameter is activated it has priority over others and deactivates the button ON/OFF on the display and the ON/OFF on the RCC-02/-03.

9.4.6.7.3 Activated by AUX1 state {14203}

This parameter redirects the state of the auxiliary relay 1 (AUX1) on the remote entry. This way it is possible, without cables, to use the state of the auxiliary relay 1 to activate the remote entry. Attention, the final state of the remote entry will be the logical combination "OR" of the state of the Aux 1 relay and the physical remote entry input.

In "EDGE" mode, the activation of the remote entry given the state of Aux 1 is not possible.

9.4.6.7.4 Start equalization {14204}

When this parameter is activated, an active remote entry starts an equalization and an inactive remote entry stops an on-going equalisation.

9.4.6.7.5 Send a message when remote entry changes state {14205}

When this parameter is activated, an active remote entry sends a message to inform when the remote entry is enabled, and an inactive remote entry sends a message to inform when the remote entry is disabled.

9.4.6.8 Reset PV energy meter {14182}

This parameter allows you to reset the PV energy meter to zero. This could be useful if you wish to measure the energy produced over a given time interval.

9.4.6.9 Reset daily solar production meters {14051} and

9.4.6.10 Reset daily min-max {14052}

These parameters allow you to reset to zero the different corresponding daily meters. This could be useful if you wish to know these values precisely over a specific period of time.

9.4.6.11 Restore default settings {14067}

See basic parameters, chap. 9.4.4.5.

9.4.6.12 *INSTALLER: Restore factory settings {14068}*

See basic parameters, chap. 9.4.4.6

9.4.6.13 *INSTALLER - Parameters saved in flash memory {14069} (yes)*

This parameter allows you to determine if the parameters modified within your system should be saved or not to the flash memory. With the objective to increase the useful life of the flash memory in the case of repeated writing to it, this parameter should be deactivated (no), for example, if the VarioString is piloted by an external control and supervision system, SCADA.

9.4.6.14 ON of the VarioString {14038}

This parameter allows to turn on all the VarioString in the system.

9.4.6.15 OFF of the VarioString {14039}

This parameter allows to turn off all the VarioString in the system.

9.4.6.16 Reset of all VarioString {14059}

This parameter allows to restart all the VarioString in the system.

9.4.7 Auxiliary contacts 1 {14070} and 2 {14122}

When connected to the ARM-02 module (see chap. 10.3 – p. 48), the solar charge controller VarioString has two additional external auxiliary relays with potential-free dry reversing contacts. These two relays make it possible to realize multiple functions with appropriate cabling and simple programming.

The programming of each contact is made independently. The auxiliary contacts are activated and deactivated with a 2 second delay to avoid too frequent switching.

The auxiliary contacts react to different types of signals, graphically illustrated below. Basic events that activate the contacts are:

- Simple events
- Scheduled events
- Levels

In the following descriptions, each parameter has two reference numbers. The reference number on the left refers to the auxiliary contact 1 and the reference number on the right refers to the auxiliary contact 2. ({reference auxiliary contact 1} {reference auxiliary contact 2}).

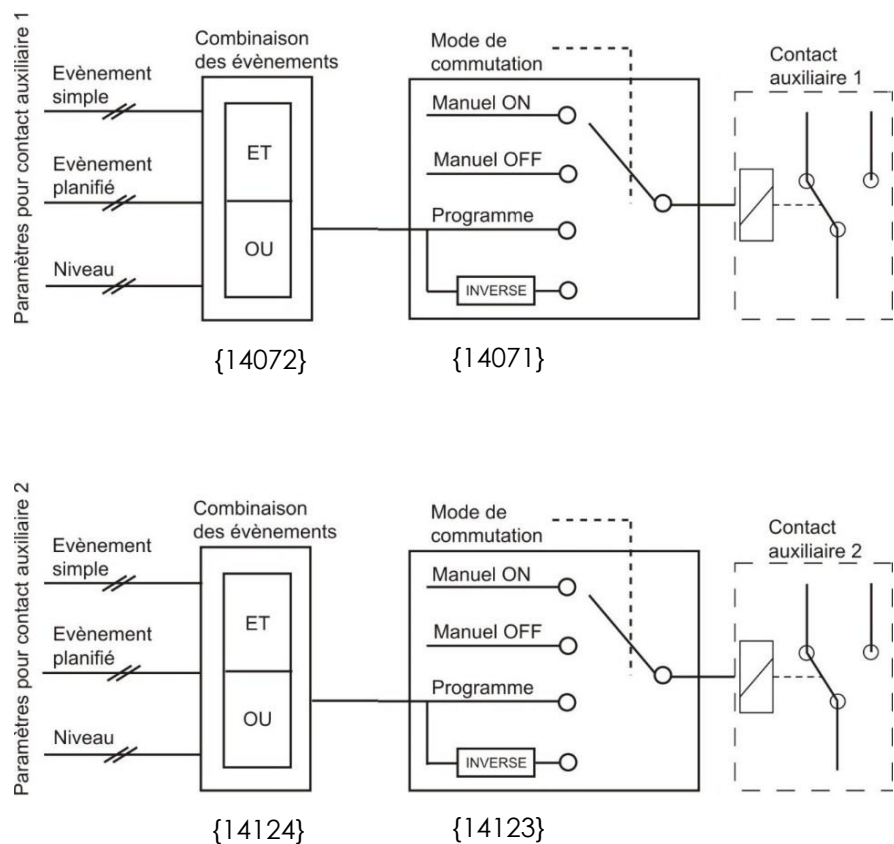

9.4.7.1 Operating mode {14071} {14123} (automatic)

The auxiliary contact can be controlled in 4 different ways:

Manual ON: in this mode, the contact is permanently activated "ON" whatever the external conditions or programming.

Manual OFF: in this mode, the contact is permanently deactivated "OFF" whatever the external conditions or programming.

Automatic: in this mode the auxiliary contact is activated according to the conditions and restrictions of its programming.

Reversed automatic: in this mode, the conditions and restrictions define the deactivation of the relay.

9.4.7.2 Combination of the events for the auxiliary contact {14072} {14124} (first active (OR))

This parameter defines how various events intended to activate the auxiliary contact are combined. The contact can be activated either by a single event (OR function) or by all events being fulfilled at the same time (AND function).

9.4.7.3 Contacts activated in night mode {14073} {14125}

The auxiliary contact can be activated with the function "night mode". When the "night mode" is activated and the activation delay is up, the auxiliary contacts will be active for a predefined time period. If the activation time is set to zero, the auxiliary contact will remain permanently activated until the end of the night mode.

- Activated in night mode {14074} {14126} (no)
- Delay of activation after entering night mode {14075} {14127} (1 min)
- Activation time for the auxiliary relay in night mode {14076} {14128} (1 min)

9.4.7.4 Contact active with a fixed time schedule {14206} {14210} (menu)

The auxiliary contacts can be activated with a fixed time schedule. Once the mode "Fixed time schedule" is activated and it is past the start hour, the auxiliary contacts will be active until it is past the set end hour.

- Contact activated with fixed time schedule (AUX1) {14207} {14211} (no)
- Start hour (AUX1) {14208} {14212} (hh:mm)
- End hour (AUX 1) {14209} {14213} (hh:mm)

9.4.7.5 Contacts activated by an event {14077} {14129}

Different states and events within the installation can be used to activate the auxiliary contacts. The events can be combined with each other to create complex functions.

9.4.7.5.1 VarioString is ON {14188} {14189} (no)

The contact is activated if the VarioString is switched ON.

9.4.7.5.2 VarioString is OFF {14078} {14130} (no)

The contact is activated if the VarioString is switched OFF.

9.4.7.5.3 Remote entry (AUX 1) {14214}{14215}((no) (available as from software version 1.5.22)

The contact is activated depending on the state of the remote entry.

9.4.7.5.4 Battery undervoltage {14079} {14131} (no)

The contact is activated in the event of battery undervoltage.

9.4.7.5.5 Battery overvoltage {14080} {14132} (no)

The contact is activated in the event of battery overvoltage.

9.4.7.5.6 Earth fault {14081} {14133} (no)

The contact is activated in the event of an earth fault.

9.4.7.5.7 PV error (48h without charge) {14082} {14134} (no)

The contact is activated in case the battery has not been charged in the last 48 hours.

9.4.7.5.8 Overtemperature {14083} {14135} (no)

The contact is activated in the event of over temperature of the device.

9.4.7.5.9 Bulk charge phase {14084} {14136} (no)

The auxiliary contact is activated if the battery is charging in the bulk phase.

9.4.7.5.10 Absorption phase {14085} {14137} (no)

The auxiliary contact is activated if the battery is charging in the absorption phase.

9.4.7.5.11 Equalization phase {14086} {14138} (no)

The auxiliary contact is activated if the battery is charging in the equalization phase.

9.4.7.5.12 Floating phase {14087} {14139} (no)

The auxiliary contact is activated if the battery is charging in the floating phase.

9.4.7.5.13 Reduced floating phase {14088} {14140} (no) and**9.4.7.5.14 Periodic absorption phase {14089} {14141} (no)**

You can activate the auxiliary contacts on the reduced floating phase and periodic absorption

phase in presence of an Xtender and synchronised with the battery cycle.

9.4.7.6 *Contacts activated by the battery voltage {14090} {14142}*

These parameters activate the auxiliary contacts if the voltage drops below a pre-defined voltage level during a set period. It is possible to define three voltages linked with three periods to activate the auxiliary contact.

The auxiliary contact will only become deactivated when the battery has risen above a certain voltage and a certain period, both values independent of the activation parameters.

This voltage and time period for deactivation is also programmable.

The contact can also be deactivated when the battery has reached the floating phase.

- Battery voltage 1 activated {14091} {14143} (no)
- Battery voltage 1 {14092} {14144} (46.8 Vdc)
- Delay 1 {14093} {14145} (1 min)

- Battery voltage 2 activated {14094} {14146} (no)
- Battery voltage 2 {14095} {14147} (47.8 Vdc)
- Delay 2 {14096} {14148} (10 min)

- Battery voltage 3 activated {14097} {14149} (no)
- Battery voltage 3 {14098} {14150} (48.5 Vdc)
- Delay 3 {14099} {14141} (60 min)

- Battery voltage to deactivate the auxiliary contact {14100} {14152} (54 Vdc)
- Delay to deactivate {14101} {14153} (60 min)
- Deactivate if battery in floating phase {14102} {14154} (no)

9.4.7.7 *Contacts activated by the battery temperature {14103} {14155}*

You can activate an auxiliary contact according to the battery temperature. This function is available with the battery temperature sensor BTS-01 or with the battery status processor BSP. Two distinct levels allow the contact to switch "ON" and "OFF" at different temperatures.

- Contact activated with the battery temperature {14104} {14156} (no)
- Activation temperature for the auxiliary contact {14105} {14157} (3°C)
- Deactivation temperature for the auxiliary contact {14106} {14158} (5°C)

9.4.7.8 *Contacts activated on the battery's state of charge (SOC) {14108} {14160} (only available in the presence of a BSP)*

You can activate the auxiliary contacts according to the state of charge of the battery (SOC). If the SOC falls below the set level, the contact will be activated. A time period can be associated with the SOC level to stipulate that the battery must be below the set level a certain time before the contact is activated. Three voltage limits with associated delay periods are available for programming.

The contact is deactivated when the battery's SOC rise above the pre-set level which can also be associated with a time period.

The contact may also be deactivated when the battery reaches the floating phase.

- Contact activated at SOC 1 {14109} {14161} (no)
- Contact activated below SOC 1 {14110} {14162} (50% SOC)
- Delay 1 {14111} {14163} (12 h)

- Contact activated at SOC 2 {14112} {14164} (no)
- Contact activated below SOC 2 {14113} {14165} (30%)
- Delay 2 {14114} {14166} (0.2 h)

- Contact activated at SOC 3 {14115} {14167} (no)
- Contact activated below SOC 3 {14116} {14168} (20%)
- Delay 3 {14117} {14169} (0 h)

- Contact deactivated below SOC {14118} {14170} (90% SOC)
- Deactivation time {14119} {14171} (0.2 h)
- Deactivation if the battery is in floating phase {14120} {14172} (no)

9.4.7.9 **Reset all settings {14121} {14173}**

This parameter is used to cancel all the programming that has been made on the corresponding auxiliary contact. Once this parameter is executed, the auxiliary contact will not activate.



Caution, this parameter cannot be cancelled.

	Use this parameter before programming any functions in the auxiliary contact. This way, you are sure that you begin programming without any previous programming that will activate the contact involuntarily.
---	--

10 ACCESSORIES

10.1 REMOTE CONTROL AND PROGRAMMING CENTRE RCC-02/03

This accessory is an important complement to the VarioString. It can be connected via one of the two communication connectors "Com. Bus" (8) (see chap. 4.1) thanks to the cable supplied with the remote control.

	When the remote control RCC-02/03 is connected to another compatible device (Xtender, VarioString, BSP, Xcom or other) with the same communication bus it is possible that the software versions are not compatible. It is highly recommended to make a software update of all components in the system in order to guarantee all functionalities. Therefore, before starting the setup of the device, download the latest software version from our website: www.studer-innotec.com on an SD card. Follow the instructions in the RCC manual for a successful installation.
	These connectors must be used only to connect a compatible Xtender accessory.

The remote control RCC-02/03 is compatible with the following equipment:

- **VarioTrack** MPPT solar charge controller
- **VarioString** MPPT solar charge controller
- **Xtender** inverter/chargers

When it is connected to at least one of these three devices, it also allows interacting with the other peripherals of an Xtender system, i.e.:

- Battery Status Processor **BSP-500/BSP1200**
- RS 232 communication interface: **Xcom-232i**
- Communication sets: **Xcom-LAN/-GSM**
- Communication module: **Xcom-SMS**

It allows the following functionalities for all the connected and compatible equipment:

- Setting the various operating parameters for the connected equipment.
- Displaying the operating synoptic for each part of the equipment.
- Displaying several operating quantities measured or calculated (Current/Voltage/Power, etc.) for each apparatus.
- Updating the software or implementing tailored software.
- Backing up/restoring system parameters (configuration).
- Loading a parameter file (configuration).
- Storing error message history for each device.
- Recording VarioString(s) data and other information essential for the system (see chapter "Data recorder" in the RCC manual).

RCC-02



RCC-03



Functionalities of the RCC-02 and RCC-03 units are equivalent. They differ only in their external aspect. The RCC-02 is designed for wall mounting whereas the RCC-03 is designed for board mounting.

Model RCC-03 must be removed from the board to access the SD card slot (during updating, for example).

Reference number Studer Innotec	Dimensions H x L x l [mm]
RCC-02	170 x 168 x 43.5
RCC-03	130 x 120 x 42.2

	Both remote control models are supplied with a 2m cable. Cables of specific lengths (5m, 20m and 50m) can be ordered. Item reference: CAB-RJ45-8-xx. The length in metres is specified by xx.
--	---

It is possible to connect up to 2 RCC or Xcom to a single VarioString, and up to 3 RCC or Xcom to a system with several VarioString or Xtender units.

	The termination switch of the communication bus "Com. Bus" (9) remains in position T (terminated) except when <u>both</u> connectors (8) are used. In this case and only in this case, the switch must be placed in the O (open) position.
--	--

10.2 TEMPERATURE SENSOR BTS-01

The operating voltages for lead batteries vary depending on the temperature. A temperature sensor is optionally available to correct the battery voltage and guarantee an optimum charge for whatever battery temperature. The correction factor given by the temperature sensor is set by parameter {14035}.

A single temperature sensor connected to one of the devices is enough in a system containing several VarioString connected to the same battery bank (multi-system).

Reference no. for the temperature sensor (including a 5m cable): BTS-01. Dimensions: H x L x l / / 58 x 51.5 x 22mm.



10.2.1 Connecting the temperature sensor (BTS-01)

The optional temperature sensor BTS-01 is supplied with a 5m cable fitted with RJ11/6-type plugs. It may be connected or disconnected at any time (even when the device is operating) using the corresponding socket (7) marked "BTS & ARM02" on the VarioString. Plug the connector into the socket (7) until it clicks in. The temperature sensor case may simply be stuck onto the battery or directly next to it. The temperature sensor is automatically recognised and the correction of the voltage thresholds applied immediately. If a BSP battery probe next to the battery is used, a BTS-01 is not necessary. The BSP module is fitted with a temperature sensor. If both elements (BTS-01 and BSP) are present, only the BTS-01 is taken into account to correct the battery temperature.

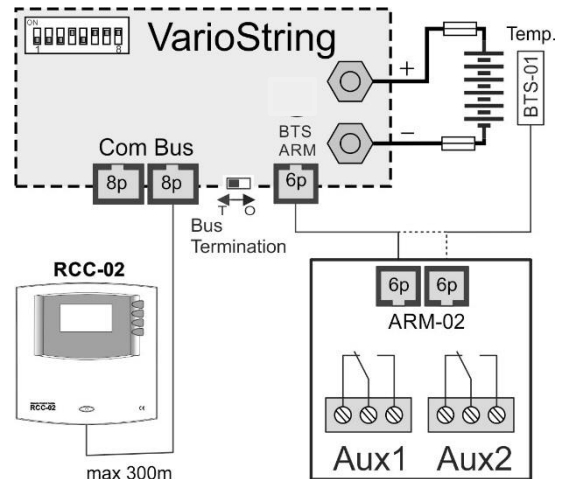

10.3 AUXILIARY RELAY MODULE ARM-02

This external module is mounted on DIN rail and connected to the same connector as the battery temperature sensor (7) by using a 5m cable supplied with the accessory. If the connector (7) is already occupied by the battery temperature sensor BTS, unplug the temperature, plug in the ARM module in its place and connect the battery temperature sensor to the ARM module.

The auxiliary relay module allows the VarioString to have 2 independent relays, each of which are fully programmable.

The maximum currents and voltages allowed by these contacts are 16A for 230Vac and 3A for 50Vdc.

The contact is active when the neighbouring LED is lit up.

The relays are by default deactivated at without programming. To program the functions on the auxiliary relays, an RCC-02/03 remote control is necessary. For the parameter description, please see the programming section of chap. 9.4.3.1



10.4 PARALLEL CONNECTION CABLE

This cable allows for the quick and secure connection of two PV strings in parallel on the VarioString VS-120.



11 EQUIPMENTS COMPATIBLE WITH THE VARIOSTRING

When making hybrid energy systems, VarioString units are often combined with Xtender inverter/chargers mentioned below. They then belong to a system where they are interconnected via the communication bus. The full description of this equipment is available on our website: www.studer-innotec.com

11.1 XTENDER INVERTER/CHARGERS

The VarioString is compatible with the entire Xtender range and it allows making PV/generator or PV/network hybrid systems that are perfectly coherent. The communication between the Xtender(s) and the VarioString(s) allow synchronizing the charging cycles of both systems. When the function is activated using parameter {14036}, the Xtender is the master of the charge profile and will impose the voltage limits set by its cycle. It will remain so even if the equipment (Xtender) is turned off using the ON/OFF button or the charger mode is prohibited.

On the other hand, if the Xtender is turned off using the main ON/OFF button (de-energized), the VarioString operates with its programmed values.



The charging current of the equipment add up with no priority. When the Xtender charging current is for example set to 100A and the VarioString supplies 120A, the battery charging current may be 220A during the bulk phase.

11.2 BATTERY STATUS PROCESSOR BSP- 500/1200

This module, supplied with a 500 or 1200A shunt, allows measuring the current, voltage and temperature of the battery. It calculates and supplies the system with all the information obtained from these measurements such as the state of charge, time before discharge, history of the state of charge over 5 days, etc.



11.3 COMMUNICATION MODULE XCOM-232I

This isolated RS232 module allows accessing most of the values and parameters of the equipment connected to the communication bus. It also features an SD card for the acquisition of measured data, settings and history of the event generated by the equipment.



11.4 COMMUNICATION SETS XCOM-LAN/-GSM

These two sets provide the possibility to control the Xtender, VarioTrack and VarioString systems via the Xcom web portal anywhere there is internet access, via the local network or via the GSM network. The access to internet can be done with a smartphone, tablette or notebook computer.



11.5 COMMUNICATION MODULE XCOM-SMS

The communication module Xcom-SMS makes it possible to access systems with Studer Innotec devices through SMS (Short Message Service) sent from a mobile phone, a web site, etc. It provides the user with a tool that gives easy access to the system in order to know its current state and to control it remotely reducing the necessity to physically go to the site.



11.6 MULTI-PROTOCOL COMMUNICATION MODULE XCOM-CAN

This tool has two main functions. It makes it possible for batteries with CAN-bus communication (typically Lithium Battery Management Systems, BMS) to interact with products of the Xtender / VarioTrack / VarioString family. The Xcom-CAN also allows for any device with a CAN-bus (PC, PLC and microcontroller) to control an installation using a proprietary protocol (Studer Public Protocol for Xcom-CAN).



12 WIRING EXAMPLES

12.1 VARIOSTRING + RCC-02

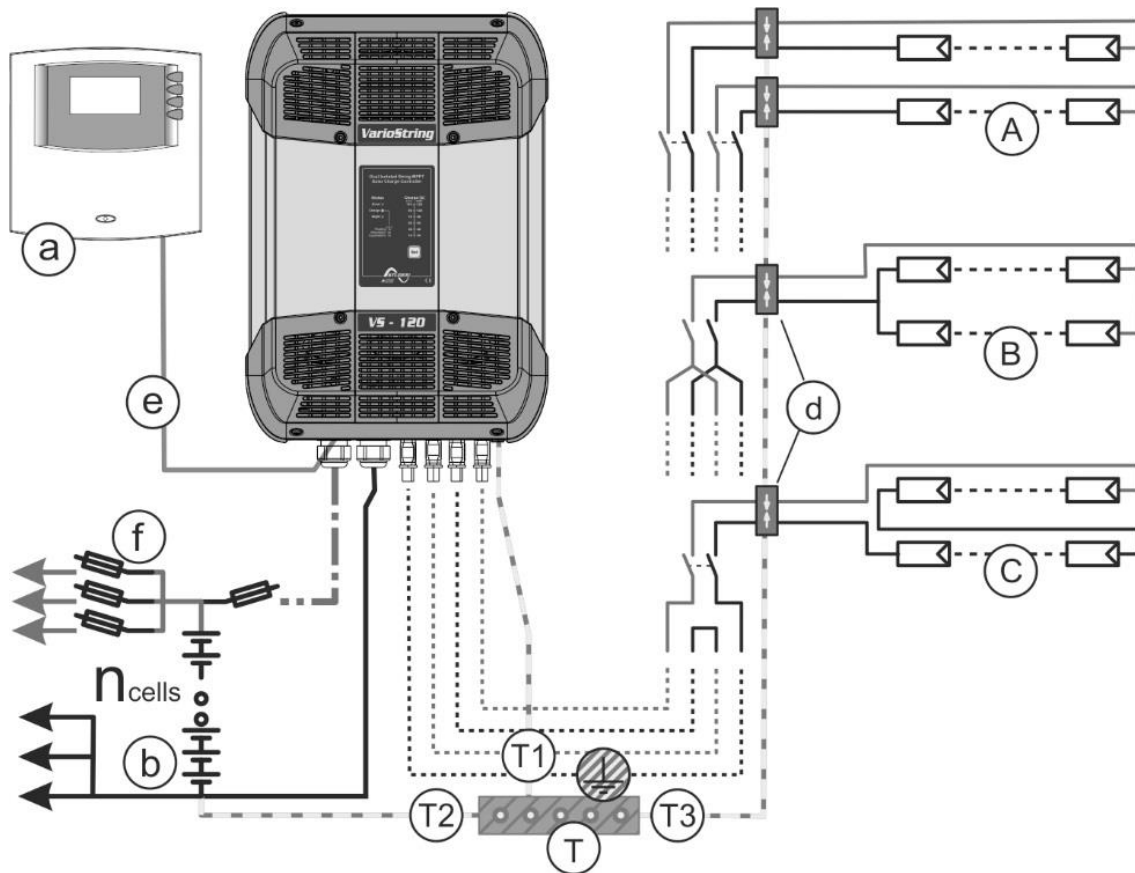

12.2 COMMENTS ON THE WIRING EXAMPLES 12.1

Elem.	Description	Refer to
a	Remote control	See chap. 10.1, 9.2
b	Battery	See chap. 4.2
d	Lightning protection device	See chap. 4.5
e	Communication cable	See chap. 4.6
f	DC protection device	See chap. 4.2.3
T	Protective earth	*Main protective earth/protective equipotential bonding connected to the conductive and accessible parts of the building and if possible, connected to a standard earth electrode.
T1	Protective earth for the equipment	*The equipment is designed to be connected to a protective earth (Class I) to which they must be connected.
T2	Protective earth for the battery	*One of the battery poles must be earthed. The other configurations must meet the recommendations at chap. 4.3.8
T3	Protective earth for the solar generator	*The protective earth for the PV generator and its lightning protection device are connected separately to the main protective earth (local equipotential bonding).
A	Independent connection	For two different PV strings, each with voltage up to 600V and independent MPPTs
B	Connection in parallel	For two different PV strings, each with voltage up to 600V
C	Connection in series	For a single PV string with voltage up to 900V

* National installation standards specific to the chosen application field must absolutely and as a priority be respected under the installer's responsibility.

12.3 VARIOSTRING VS-70 + RCC-02

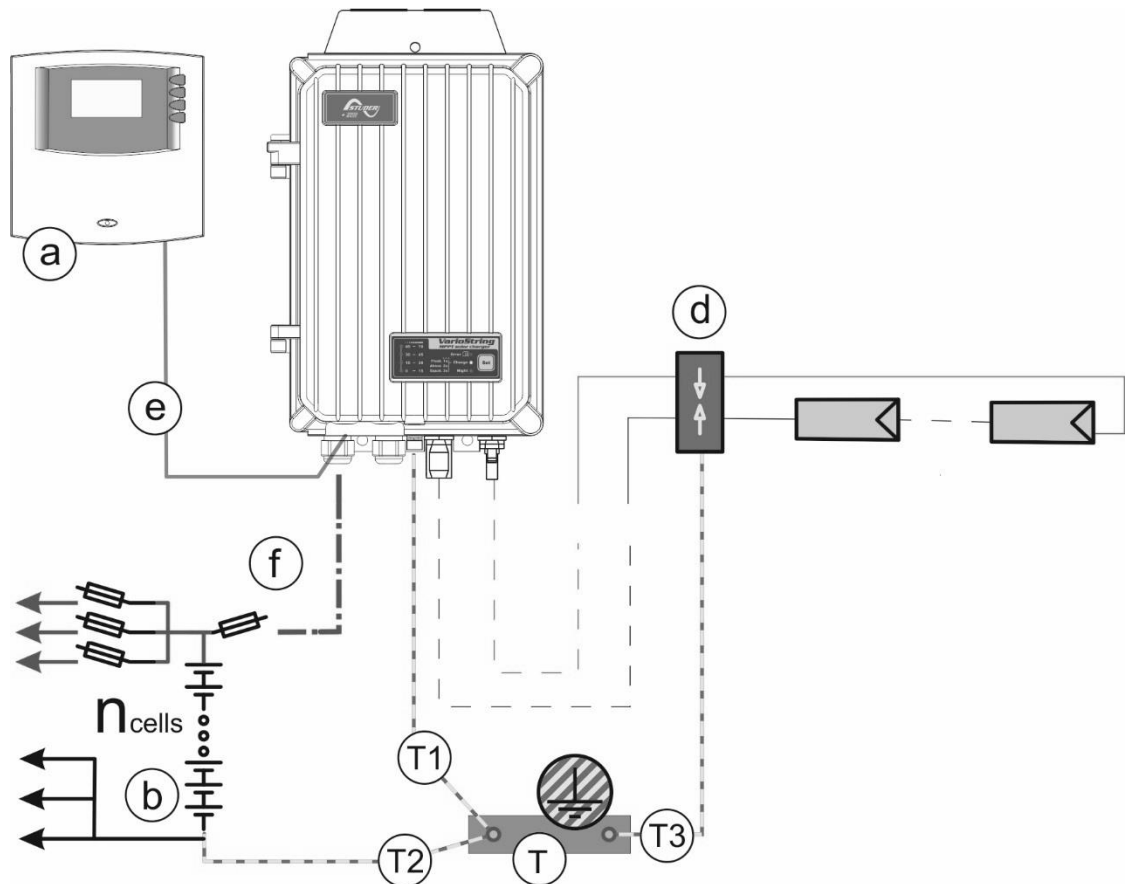

12.4 COMMENTS ON THE WIRING EXAMPLES 11.3

Elem.	Description	Refer to
a	Remote control	See chap. 10.1, 9.2
b	Battery	See chap. 4.2
d	Lightning protection device	See chap. 4.5
e	Communication cable	See chap. 4.6
f	DC protection device	See chap. 4.2.3
T	Protective earth	*Main protective earth/protective equipotential bonding connected to the conductive and accessible parts of the building and if possible, connected to a standard earth electrode.
T1	Protective earth for the equipment	*The equipment is designed to be connected to a protective earth (Class I) to which they must be connected.
T2	Protective earth for the battery	*One of the battery poles must be grounded. The other configurations must meet the recommendations at chap. 4.4.
T3	Protective earth for the solar generator	*The protective earth for the PV generator and its lightning protection device are connected separately to the main protective earth (local equipotential bonding).

13 MAINTENANCE OF THE INSTALLATION

Except for the periodic check of the connections (tightening, general condition) the VarioString does not require any particular maintenance.

14 PRODUCT RECYCLING

The VarioString meets the European directive 2011/65/EU on hazardous substances and does not contain the following elements: lead, cadmium, mercury, hexavalent chrome, PBB or PBDE.

To dispose of this product, please use the service for the collection of electrical waste and observe all obligations in force in the place of purchase.

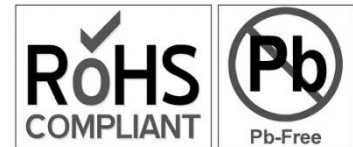

15 EU DECLARATION OF CONFORMITY

The charge regulator described in this manual has been designed and manufactured in accordance with the following directives and harmonized standards.

Low Voltage Directive (LVD) 2014/35/EU

- EN 62109-1:2010

Electromagnetic Compliance (EMC) Directive 2014/30/EU

- EN 61000-6-1:2007

- EN 61000-6-2:2005

- EN 61000-6-3:2007/A1:2011

- EN 61000-6-4:2007/A1:2011

16 TROUBLE-SHOOTING

Mes. nr	Messages description	Troubleshoot
0	Warning (000): Battery low	The battery voltage is below the battery undervoltage level set by {14216}. The device will not turn off.
12	(012): Use of battery temperature sensor	Indicates the presence of a BTS-01 temperature probe connected to the device that sent the message.
14	Halted (014): Over temperature EL	The device is stopped after surpassing the max internal electronics temperature.
16	Warning (016): Fan error detected	The external ventilation module (ECF-01) is defective or has been disconnected during the functioning of the device.
20	Halted (020): Battery overvoltage	Slow or fast battery overvoltage
80	Halted (080): No battery (or reverse polarity)	The battery voltage must be greater than 3V in order for it to be detected.
81	Warning (081): Earthing fault	The configured limits for the earth potential have been exceeded. The wiring of the installation should be verified.
84	(084): Equalization performed	Indicates that the equalization phase has finished correctly. The message is not sent when the end of the equalization phase is forced by one of the following parameters (signals): {1467}, {1142}, {10006}, {10010}, {10029}, {14006}, {14010}, {14028}.
138	Error (138): XT master synchronization lost	No synchronisation with the Xtender for 10 s.
140	(140): Synchronized on XT master	Sent after receiving the first frame of synchronization with the Xtender.
150	Error (150): Cabling error between PV and VarioString	Check that the cable connections of the PV modules corresponds to the type of cabling set in parameter settings.
168	(168): Synchronized with VarioString master	Sent after receiving the first frame of synchronization with VS.
169	(169): Synchronization with VarioString master lost	Sent if the synchronization with the VS has not been received in the past 10s.
170 171	Warning (170): No solar production in the last 48h on PV1 Warning (171): No solar production in the last 48h on PV2	Check that the PV modules are connected correctly and the state of protection equipment (fuses and circuit breakers).
180	(180): Command entry activated	When parameter {14205} is used, a message is sent in the event of activation of the remote entry.
211	(211): Command entry deactivated	When parameter {14205} is used, a message is sent in the event of deactivation of the remote entry.
213	(213): Battery current limitation by the BSP stopped	Message sent by master 2 seconds after stopping to receive a signal for limiting the current from the BSP.

17 PARAMETER LIST

Level	Nr	VarioString parameter description	Factory value	User value
Expert	14001	Battery charge current (VS-120)	120 Adc	
Basic	14002	Configuration of PV modules (VS-120)	Automatic	
Expert	14005	Floating voltage	54.4 Vdc	
Expert	14006	Force phase of floating	-	
Expert	14008	Absorption phase allowed	Yes	
Expert	14009	Absorption voltage	57.6 Vdc	
Expert	14010	Force absorption phase	-	
Expert	14011	Absorption duration	120 min	
Expert	14012	End of absorption triggered by the current	No	
Expert	14013	Current threshold to end absorption phase	10 Adc	
Expert	14017	Equalization allowed	No	
Expert	14018	Force equalization	-	
Expert	14019	Equalization before absorption phase	Yes	
Expert	14020	Equalization current	80 Adc	
Expert	14021	Equalization voltage	62.4 Vdc	
Expert	14022	Equalization duration	30 min	
Expert	14023	Equalization with fixed interval	Yes	
Expert	14024	Days between equalizations	26 days	
Expert	14025	End of equalization triggered by the current	No	
Expert	14026	Current threshold to end equalization phase	10 Adc	
Expert	14028	Force a new cycle	-	
Expert	14029	Voltage level 1 to start a new cycle	48.8 Vdc	
Expert	14030	Time period under voltage level 1 to start a new cycle	30 min	
Expert	14031	Voltage level 2 to start a new cycle	47.2 Vdc	
Expert	14032	Time period under voltage level 2 to start a new cycle	2 min	
Expert	14033	Cycling restricted	Yes	
Expert	14034	Minimal delay between cycles	1 hours	
Expert	14035	Temperature compensation	-3 mV/°C/cell	
Basic	14036	Synchronisation battery cycle with Xtender	Yes	
Expert	14038	ON of the VarioString	-	
Expert	14039	OFF of the VarioString	-	
Expert	14040	Type of battery grounding	No control	
Expert	14041	Type of PV grounding	No control	
Expert	14042	Type of PV2 grounding	No control	
Expert	14043	Type of MPP tracking algorithm PV	LSF	
Expert	14044	PV voltage fixed (for PV in series)	700 Vdc	
Expert	14045	Ratio of PV open circuit voltage	0.7	
Expert	14046	Type of MPP tracking algorithm PV2	LSF	
Expert	14047	PV2 voltage fixed	500 Vdc	
Expert	14048	Ratio of PV2 open circuit voltage	0.7	
Expert	14051	Reset daily solar production meters	-	
Expert	14052	Reset daily min-max	-	
Expert	14059	Reset of all VarioString	-	
Expert	14065	Battery overvoltage level	68.2 Vdc	
Expert	14066	Restart voltage level after a battery overvoltage	64.8 Vdc	
Basic	14067	Restore default settings	-	

Inst.	14068	Restore factory settings	-	
Inst.	14069	Parameters saved in flash memory	Yes	
Expert	14071	Operating mode (AUX 1)	Automatic	
Expert	14072	Combination of the events for the auxiliary contact (AUX 1)	Any (Function OR)	
Expert	14074	Activated in night mode (AUX 1)	No	
Expert	14075	Delay of activation after entering night mode (AUX 1)	1 min	
Expert	14076	Activation time for the auxiliary relay in night mode (AUX 1)	1 min	
Expert	14078	VarioString is OFF (AUX 1)	No	
Expert	14079	Battery undervoltage (AUX 1)	No	
Expert	14080	Battery overvoltage (AUX 1)	No	
Expert	14081	Earth fault (AUX 1)	No	
Expert	14082	PV error (48h without charge) (AUX 1)	No	
Expert	14083	Overtemperature (AUX 1)	No	
Expert	14084	Bulk charge phase (AUX 1)	No	
Expert	14085	Absorption phase (AUX 1)	No	
Expert	14086	Equalization phase (AUX 1)	No	
Expert	14087	Floating (AUX 1)	No	
Expert	14088	Reduced floating (AUX 1)	No	
Expert	14089	Periodic absorption (AUX 1)	No	
Expert	14091	Battery voltage 1 activate (AUX 1)	No	
Expert	14092	Battery voltage 1 (AUX 1)	46.8 Vdc	
Expert	14093	Delay 1 (AUX 1)	1 min	
Expert	14094	Battery voltage 2 activate (AUX 1)	No	
Expert	14095	Battery voltage 2 (AUX 1)	47.8 Vdc	
Expert	14096	Delay 2 (AUX 1)	10 min	
Expert	14097	Battery voltage 3 activate (AUX 1)	No	
Expert	14098	Battery voltage 3 (AUX 1)	48.5 Vdc	
Expert	14099	Delay 3 (AUX 1)	60 min	
Expert	14100	Battery voltage to deactivate (AUX 1)	54 Vdc	
Expert	14101	Delay to deactivate (AUX 1)	60 min	
Expert	14102	Deactivate if battery in floating phase (AUX 1)	No	
Expert	14104	Contact activated with the temperature of battery (AUX 1)	No	
Expert	14105	Contact activated over (AUX 1)	3 °C	
Expert	14106	Contact deactivated below (AUX 1)	5 °C	
Expert	14107	Only activated if the battery is not in bulk phase (AUX 1)	No	
Expert	14109	Contact activated with the SOC 1 of battery (AUX 1)	No	
Expert	14110	Contact activated below SOC 1 (AUX 1)	50 % SOC	
Expert	14111	Delay 1 (AUX 1)	12 hours	
Expert	14112	Contact activated with the SOC 2 of battery (AUX 1)	No	
Expert	14113	Contact activated below SOC 2 (AUX 1)	30 %	
Expert	14114	Delay 2 (AUX 1)	0.2 hours	
Expert	14115	Contact activated with the SOC 3 of battery (AUX 1)	No	
Expert	14116	Contact activated below SOC 3 (AUX 1)	20 %	
Expert	14117	Delay 3 (AUX 1)	0 hours	

Expert	14118	Contact deactivated over SOC (AUX 1)	90 % SOC	
Expert	14119	Delay to deactivate (AUX 1)	0.2 hours	
Expert	14120	Deactivate if battery in floating phase (AUX 1)	No	
Expert	14121	Reset all settings (AUX 1)	-	
Expert	14123	Operating mode (AUX 2)	Automatic	
Expert	14124	Combination of the events for the auxiliary contact (AUX 2)	Any (Function OR)	
Expert	14126	Activated in night mode (AUX 2)	No	
Expert	14127	Delay of activation after entering night mode (AUX 2)	1 min	
Expert	14128	Activation time for the auxiliary relay in night mode (AUX 2)	1 min	
Expert	14130	VarioString is OFF (AUX 2)	No	
Expert	14131	Battery undervoltage (AUX 2)	No	
Expert	14132	Battery overvoltage (AUX 2)	No	
Expert	14133	Earth fault (AUX 2)	No	
Expert	14134	PV error (48h without charge) (AUX 2)	No	
Expert	14135	Overtemperature (AUX 2)	No	
Expert	14136	Bulk charge phase (AUX 2)	No	
Expert	14137	Absorption phase (AUX 2)	No	
Expert	14138	Equalization phase (AUX 2)	No	
Expert	14139	Floating (AUX 2)	No	
Expert	14140	Reduced floating (AUX 2)	No	
Expert	14141	Periodic absorption (AUX 2)	No	
Expert	14143	Battery voltage 1 activate (AUX 2)	No	
Expert	14144	Battery voltage 1 (AUX 2)	46.8 Vdc	
Expert	14145	Delay 1 (AUX 2)	1 min	
Expert	14146	Battery voltage 2 activate (AUX 2)	No	
Expert	14147	Battery voltage 2 (AUX 2)	47.8 Vdc	
Expert	14148	Delay 2 (AUX 2)	10 min	
Expert	14149	Battery voltage 3 activate (AUX 2)	No	
Expert	14150	Battery voltage 3 (AUX 2)	48.5 Vdc	
Expert	14151	Delay 3 (AUX 2)	60 min	
Expert	14152	Battery voltage to deactivate (AUX 2)	54 Vdc	
Expert	14153	Delay to deactivate (AUX 2)	60 min	
Expert	14154	Deactivate if battery in floating phase (AUX 2)	No	
Expert	14156	Contact activated with the temperature of battery (AUX 2)	No	
Expert	14157	Contact activated over (AUX 2)	3 °C	
Expert	14158	Contact deactivated below (AUX 2)	5 °C	
Expert	14159	Only activated if the battery is not in bulk phase (AUX 2)	No	
Expert	14161	Contact activated with the SOC 1 of battery (AUX 2)	No	
Expert	14162	Contact activated below SOC 1 (AUX 2)	50 % SOC	
Expert	14163	Delay 1 (AUX 2)	12 hours	
Expert	14164	Contact activated with the SOC 2 of battery (AUX 2)	No	
Expert	14165	Contact activated below SOC 2 (AUX 2)	30 %	
Expert	14166	Delay 2 (AUX 2)	0.2 hours	
Expert	14167	Contact activated with the SOC 3 of battery (AUX 2)	No	

Expert	14168	Contact activated below SOC 3 (AUX 2)	20 %	
Expert	14169	Delay 3 (AUX 2)	0 hours	
Expert	14170	Contact deactivated over SOC (AUX 2)	90 % SOC	
Expert	14171	Delay to deactivate (AUX 2)	0.2 hours	
Expert	14172	Deactivate if battery in floating phase (AUX 2)	No	
Expert	14173	Reset all settings (AUX 2)	-	
Expert	14174	Block manual programming (dip-switch)	No	
Expert	14175	Type of PV1 grounding	No control	
Expert	14176	Type of MPP tracking algorithm PV1	LSF	
Expert	14177	PV1 voltage fixed	500 Vdc	
Expert	14178	Ratio of PV1 open circuit voltage	0.7	
Expert	14179	PV voltage fixed (for PV in //)	500 Vdc	
Expert	14182	Reset PV energy meter	-	
Expert	14188	VarioString is ON (AUX 1)	No	
Expert	14189	VarioString is ON (AUX 2)	No	
Inst.	14190	PV wiring type erased from memory	-	
Inst.	14192	Establishment time (Algo MPPT)	0 sec	
Inst.	14193	Averaging time (Algo MPPT)	0 sec	
Expert	14196	Type of PV grounding	No control	
Expert	14197	Type of MPP tracking algorithm PV	LSF	
Expert	14198	PV voltage fixed	500 Vdc	
Expert	14199	Ratio of PV open circuit voltage	0.7	
Expert	14201	Remote entry active	Open	
Expert	14202	ON/OFF command	No	
Expert	14203	Activated by AUX1 state	No	
Expert	14204	Start equalization	No	
Expert	14205	Send a message when remote entry changes state	No	
Expert	14207	Contact activated with fixed time schedule (AUX 1)	No	
Expert	14208	Start hour (AUX 1)	07:00 hh:mm	
Expert	14209	End hour (AUX 1)	20:00 hh:mm	
Expert	14211	Contact activated with fixed time schedule (AUX 2)	No	
Expert	14212	Start hour (AUX 2)	07:00 hh:mm	
Expert	14213	End hour (AUX 2)	20:00 hh:mm	
Expert	14214	Remote entry (AUX 1)	No	
Expert	14215	Remote entry (AUX 2)	No	
Expert	14216	Battery undervoltage	40 Vdc	
Expert	14217	Battery charge current (VS-70)	70 Adc	
Inst.	14218	VarioString watchdog enabled (SCOM)	No	
Inst.	14219	VarioString watchdog delay (SCOM)	60 sec	

18 TECHNICAL DATA

18.1 GENERAL SPECIFICATIONS

	VarioString VS-70	VarioString VS-120
Galvanic isolation	Yes	
Maximum conversion efficiency	> 98%	
MPPT efficiency	>99%	
PV grounding possibility	PV +, PV -, floating	
Consumption max en stand-by	25 mA (1.25W)	
Warranty	5 years	
Weight	5.55 kg	7.5 kg
Dimensions h x w x l (mm)	120 x 220 x 350	133 x 322 x 466
Use in parallel	Up to 15 units	
Solar generator connection	Sunclix	
Max wire size (battery)	25 mm ²	70 mm ²
Glands (battery)	2xPG16	2xPG21

18.2 INPUT (PV GENERATOR)

	VarioString VS-70	VarioString VS-120
Maximum solar power recommended (@STC)	4200 W	7000 W
Maximum open circuit voltage (Voc)	600 V	Parallel or independent connection 600 V Connection in series 900 V
Minimum functional circuit voltage	100 V	Parallel or independent connection 100 V Connection in series 200 V
Maximum short circuit current	13A	Series or independent connection 13A Parallel connection 26A

18.3 OUTPUT (BATTERY)

	VarioString VS-70	VarioString VS-120
Nominal battery voltage	48V	
Battery input voltage range	(18V)-38- 68V	
Max. charging current of the battery at 25/40°C	70A	120 A (60A par MPPT)
Charging phases: (adjustable threshold and duration)	4 phases : Bulk, Absorption, Floating, Equalization	
Battery temperature compensation (with accessory BTS-01)	-3mV/°C/cell (ref. at 25°C) adjustable -8 to 0 mV/°C/cell	

18.4 ENVIRONMENT

	VarioString VS-70	VarioString VS-120
Operating ambient temperature range	-20°C to 55°C	
Relative moisture	Max 95%, without condensation	
Degree of protection	IP54	IP20
Mounting location	Indoors, pollution degree 2	

18.5 PROTECTION

	VarioString VS-70	VarioString VS-120
Polarity reversal of the PV generator	Protected	
Polarity reversal on the battery side	Protected (only if a fuse is present on the battery side)	
Reverse current at night	Protected (no reverse polarity is possible)	
Overtoltage on the battery side	Protected (up to 75V)	
Overtoltage on the PV side	No protection	
Over temperature	Protected	

18.6 COMMUNICATION

	VarioString VS-70	VarioString VS-120
Network cabling	Studer communication bus	
Remote control and display	RCC-02/03 / Xcom-232i / Xcom-LAN / Xcom-GSM	
Language menus	English, French, German, Spanish	
Datalogging	With RCC-02/03 on SD card, one point every minute	

18.7 COMPLIANCE

	VarioString VS-70	VarioString VS-120
EC conformity	EMC 2004/108/CE · LV 2006/95/CE · RoHS 2011/65/CE	
Security	IEC/EN 62109-1:2010	
EMC (electromagnetic compatibility)	IEC/EN 61000-6-3:2011 · IEC/EN 61000-6-1:2005	

19 INDEX OF PARAMETERS

{14000}.....	36	{14080}.....	44	{14142}.....	45
{14001}.....	25, 31, 36, 37, 38	{14081}.....	44	{14143}.....	45
{14002}.....	36	{14082}.....	44	{14144}.....	45
{14003}.....	36	{14083}.....	44	{14145}.....	45
{14004}.....	37	{14084}.....	44	{14146}.....	45
{14005}.....	25, 28, 37	{14085}.....	44	{14147}.....	45
{14006}.....	37	{14086}.....	44	{14148}.....	45
{14007}.....	37	{14087}.....	44	{14149}.....	45
{14008}.....	28, 37	{14088}.....	44	{14150}.....	45
{14009}.....	25, 26, 28, 37, 38	{14089}.....	44	{14152}.....	45
{14010}.....	37	{14090}.....	45	{14153}.....	45
{14011}.....	25, 28, 38	{14091}.....	45	{14154}.....	45
{14012}.....	25, 38	{14092}.....	45	{14155}.....	45
{14013}.....	25, 38	{14093}.....	45	{14156}.....	45
{14016}.....	38	{14094}.....	45	{14157}.....	45
{14017}.....	25, 26, 28, 38	{14095}.....	45	{14158}.....	45
{14018}.....	38	{14096}.....	45	{14160}.....	45
{14019}.....	26, 39	{14097}.....	45	{14161}.....	45
{14020}.....	38	{14098}.....	45	{14162}.....	45
{14021}.....	25, 26, 28, 38	{14099}.....	45	{14163}.....	45
{14022}.....	25, 39	{14100}.....	45	{14164}.....	45
{14023}.....	26, 39	{14101}.....	45	{14165}.....	45
{14024}.....	28, 39	{14102}.....	45	{14166}.....	45
{14025}.....	39	{14103}.....	45	{14167}.....	45
{14026}.....	39	{14104}.....	45	{14168}.....	45
{14027}.....	39	{14105}.....	45	{14169}.....	45
{14028}.....	40	{14106}.....	45	{14170}.....	45
{14029}.....	40	{14108}.....	45	{14171}.....	45
{14030}.....	40	{14109}.....	45	{14172}.....	45
{14031}.....	40	{14110}.....	45	{14173}.....	46
{14032}.....	40	{14111}.....	45	{14174}.....	27, 28, 29, 33, 36, 40
{14033}.....	40	{14112}.....	45	{14175}.....	40
{14034}.....	40	{14113}.....	45	{14176}.....	41
{14035}.....	37, 38, 47	{14114}.....	45	{14177}.....	41
{14036}.....	27, 28, 37	{14115}.....	45	{14179}	41
{14037}.....	40	{14116}.....	45	{14180}.....	40
{14038}.....	42	{14117}.....	45	{14182}.....	42
{14039}.....	42	{14118}.....	45	{14188}.....	44
{14040}.....	20, 24, 32, 40	{14119}.....	45	{14189}.....	44
{14041}.....	20, 24, 32, 40, 41	{14120}.....	45	{14190}.....	41
{14042}.....	20, 24, 32, 40	{14121}.....	46	{14194}.....	40
{14043}.....	40, 41	{14122}.....	43	{14195}.....	41
{14044}	41	{14123}.....	43	{14200}.....	41
{14045}	41	{14124}.....	43	{14201}.....	27, 41
{14046}.....	41	{14125}.....	43	{14202}.....	42
{14051}.....	42	{14126}.....	43	{14203}.....	42
{14052}.....	42	{14127}.....	43	{14204}.....	42
{14059}.....	42	{14128}.....	43	{14205}.....	42
{14067}.....	36, 42	{14129}.....	44	{14206}.....	44
{14068}.....	36, 42	{14130}.....	44	{14207}.....	44
{14069}.....	42	{14131}.....	44	{14208}.....	44
{14070}.....	43	{14132}.....	44	{14209}.....	44
{14071}.....	43, 44	{14133}.....	44	{14210}.....	44
{14072}.....	43	{14134}.....	44	{14211}.....	44
{14073}.....	43	{14135}.....	44	{14212}.....	44
{14074}.....	43	{14136}.....	44	{14213}.....	44
{14075}.....	43	{14137}.....	44	{14214}.....	44
{14076}.....	43	{14138}.....	44	{14215}.....	44
{14077}.....	44	{14139}.....	44	{14216}.....	37
{14078}.....	44	{14140}.....	44	{14217}.....	36, 37
{14079}.....	44	{14141}.....	44, 45		



Studer Innotec SA
Rue des Casernes 57
1950 Sion – Switzerland
Tel: +41(0) 27 205 60 80
Fax: +41(0) 27 205 60 88

info@studer-innotec.com
www.studer-innotec.com